

VOLUME XXXVIII

WINTER 2000

GEMS & GEMOLOGY

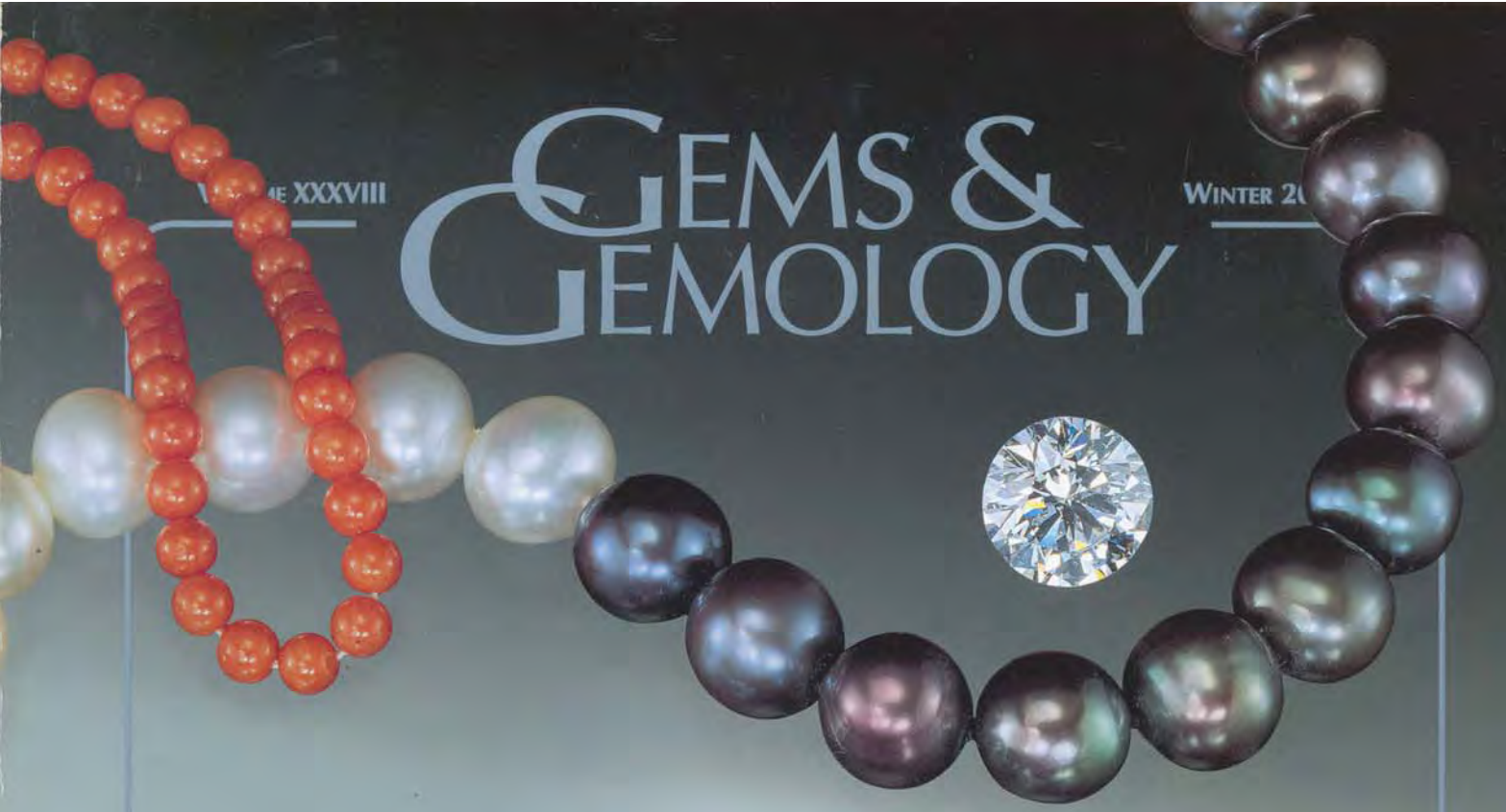

Featuring:

*Treatments Chart . . . Gemesis
Diamond Cut Patents . . . Londonite*



pg. 308



pg. 319

291 LETTERS _____

FEATURE ARTICLES _____

294 **Chart of Commercially Available Gem Treatments***Christopher P. Smith and Shane F. McClure*

Provides a comprehensive, easy-to-use reference to the most common gem enhancements on the market today and their detectability.

301 **Gemesis Laboratory-Created Diamonds***James E. Shigley, Reza Abbaschian, and Carter Clarke*

A study of the jewelry-quality yellow synthetic diamonds being grown on a commercial scale by Gemesis Corp. of Sarasota, Florida.

310 **Legal Protection for Proprietary Diamond Cuts***Thomas W. Overton*

A guide to the protection of diamond cut designs through trademarks and patents. Includes a history of diamond cut patents and a review of proprietary designs currently in the marketplace.

326 **Rhodizite-Londonite from the Antsongombato Pegmatite, Central Madagascar***Brendan M. Laurs, Federico Pezzotta, William B. (Skip) Simmons, Alexander U. Falster, and Sam Muhlmeister*

Describes the history, geology, mining, and gemological characteristics of gem-quality rhodizite-londonite from its only known source.

REGULAR FEATURES _____

340 **Gem Trade Lab Notes**

- "Piranha" agate • Surface-treated amber • Unusual ceramic pearl simulant
- More Be diffusion—rubies and orange sapphire • Diamond with internal inscriptions • Two large glass imitation jade carvings • Bleached, impregnated, and dyed jadeite with unusual inclusions • Cultured pearls with treated yellow color

348 **Gem News International**

- Kimberley Process ratified • Alexandrite from Mananjary, Madagascar • Color-change apatite from Kazakhstan • New emerald find from the Chivor region, Colombia • New jadeite from Guatemala • Milarite with unusual inclusions
- Unusual spinel crystal • More tourmalines from Warner Springs, California
- Faceted rossmanite and other tourmalines from Nigeria • Uvite tourmaline from Afghanistan • An assembled agate "nodule" • A glowing manufactured gem • "Rainbow Calsilica" • Heat treatment of faceted amber • Update on Be-diffused corundum • Orange topaz with synthetic hematite coating • Conference reports • Announcements

370 **Book Reviews**372 **Gemological Abstracts**379 **2002 Index**

pg. 355

EDITORIAL STAFF

Editor-in-Chief

Alice S. Keller
akeller@gia.edu

Publisher

William E. Boyajian

Managing Editor

Thomas W. Overton
tom.overton@gia.edu

Technical Editor

Carol M. Stockton

Contributing Editors

John I. Koivula
James E. Shigley

Editor

Brendan M. Laurs
5345 Armada Drive
Carlsbad, CA 92008
(760) 603-4504
blaurs@gia.edu

Associate Editor

Stuart Overlin
soverlin@gia.edu

Subscriptions

Debbie Ortiz
(800) 421-7250, ext. 7142
Fax: (760) 603-4595
dortiz@gia.edu

Editors, Gem Trade Lab Notes

Thomas M. Moses, Ilene Reinitz,
Shane F. McClure, and
Mary L. Johnson

Editor, Gem News International

Brendan M. Laurs

Editors, Book Reviews

Susan B. Johnson
Jana E. Miyahira-Smith

Editor, Gemological Abstracts

A. A. Levinson

Web Site: www.gia.edu/gandg

PRODUCTION STAFF

Art Director

Karen Myers

Production Assistant

Wendy Lemberg

EDITORIAL REVIEW BOARD

Alan T. Collins
London, United Kingdom

G. Robert Crowningshield
New York, New York

John Emmett
Brush Prairie, Washington

Emmanuel Fritsch
Nantes, France

Henry A. Hänni
Basel, Switzerland

C. S. Hurlbut, Jr.
Cambridge, Massachusetts

A. J. A. (Bram) Janse
Perth, Australia

Alan Jobbins
Caterham, United Kingdom

Mary L. Johnson
Carlsbad, California

Anthony R. Kampf
Los Angeles, California

Robert E. Kane
Helena, Montana

John I. Koivula
Carlsbad, California

A. A. Levinson
Calgary, Alberta, Canada

Thomas M. Moses
New York, New York

Kurt Nassau
P.O. Lebanon, New Jersey

George Rossman
Pasadena, California

Kenneth Scarratt
New York, New York

Karl Schmetzer
Petershausen, Germany

James E. Shigley
Carlsbad, California

Christopher P. Smith
Lucerne, Switzerland

SUBSCRIPTIONS

Subscriptions to addresses in the U.S. are priced as follows: **\$69.95** for one year (4 issues), **\$179.95** for three years (12 issues). Subscriptions sent elsewhere are **\$80.00** for one year, **\$210.00** for three years.

Special annual subscription rates are available for GIA Alumni Association members and students actively involved in a GIA program: **\$59.95** to addresses in the U.S., **\$70.00** elsewhere. Your student number must be listed at the time your subscription is entered.

Single copies of this issue may be purchased for **\$17.50** in the U.S.A., **\$22.00** elsewhere. Discounts are given for bulk orders of 10 or more of any one issue. A limited number of back issues of *G&G* are also available for purchase. Please address all inquiries regarding subscriptions and the purchase of single copies or back issues to the Subscriptions Department (see above), or visit www.gia.edu/gandg.

To obtain a Japanese translation of *Gems & Gemology*, contact GIA Japan, Okachimachi Cy Bldg., 5-15-14 Ueno, Taitoku, Tokyo 110, Japan. Our Canadian goods and service registration number is 126142892RT.

MANUSCRIPT SUBMISSIONS

Gems & Gemology welcomes the submission of articles on all aspects of the field. Please see the Guidelines for Authors in the Summer 2002 issue of the journal, or contact the Managing Editor for a copy. Letters on articles published in *Gems & Gemology* are also welcome.

COPYRIGHT AND REPRINT PERMISSIONS

Abstracting is permitted with credit to the source. Libraries are permitted to photocopy beyond the limits of U.S. copyright law for private use of patrons. Instructors are permitted to photocopy isolated articles for noncommercial classroom use without fee. Copying of the photographs by any means other than traditional photocopying techniques (Xerox, etc.) is prohibited without the express permission of the photographer (where listed) or author of the article in which the photo appears (where no photographer is listed). For other copying, reprint, or republication permission, please contact the Managing Editor.

Gems & Gemology is published quarterly by the Gemological Institute of America, a nonprofit educational organization for the jewelry industry, 5345 Armada Drive, Carlsbad, CA 92008.

Postmaster: Return undeliverable copies of *Gems & Gemology* to 5345 Armada Drive, Carlsbad, CA 92008.

Any opinions expressed in signed articles are understood to be the opinions of the authors and not of the publisher.

ABOUT THE COVER

For centuries, a variety of techniques have been used to enhance the appearance of gems. The chart included with this issue describes gem treatments currently in the marketplace and indicates their detectability in specific gems. Shown here are some of the gem materials that may be subjected to treatment (and the fine colors that treaters try to duplicate). The cultured pearls range from 10.28 to 11.15 mm; the coral beads are 4.5 mm. The diamond (above the necklace) is 4.10 ct. The colored stones, left to right from the top, are: (row 1) 8.28 ct aquamarine, 10.76 ct tanzanite; (row 2) 5.77 ct yellow sapphire, 8.34 ct pink tourmaline, 10.99 ct blue zircon; (row 3) 8.56 ct pink sapphire, 8.37 ct blue sapphire, 5.56 ct emerald; (bottom row) 2.42 ct pinkish orange sapphire, 3.61 ct ruby. Cultured pearls courtesy of Kathryn Kimmel, GIA. Coral courtesy of Roben Hagobian, Glendale, California. Diamond courtesy of Norman Silverman and Louis P. Cvelbar, Los Angeles. Colored stones courtesy of Evan Caplan, Omi Gems, Los Angeles. Photo © GIA and Harold & Erica Van Pelt.

Color separations for *Gems & Gemology* are by Vertis Inc., Carlsbad, California.

Printing is by Fry Communications, Inc., Mechanicsburg, Pennsylvania.

© 2002 Gemological Institute of America All rights reserved. ISSN 0016-626X

LETTERS

Kudos for the *G&G Twenty Year Index*

I would like to thank *G&G* for its online *Twenty Year Index (1981–2000)* of articles, Gem News items, and Lab Notes. I just used this valuable resource once again to find the answer to another gem mystery. The ability to search and find pertinent articles with relative ease makes my life much simpler—and I'm sure I'm not alone in this sentiment. I have one client who is always sending me "unusual" items to identify and certify. *G&G* is my "secret weapon." My clients are always amazed that someone in Boise, Idaho—of all places—actually knows what's happening in the maelstrom we lovingly call the gem and jewelry industry.

The online index will be an even greater asset once it can be updated to add the references from each issue of the journal as it's published. As an ardent fan of *G&G*, I would, of course, love to have it all . . . right now. (Actually, something like streaming "real-time" updates would be heaven.) There are plenty of us out here in the trenches who rely on this information. Without *G&G*, my appraisal/identification practice would be consummately harder. I do hope that you realize what a tremendous resource you provide to the trade.

Thanks from a grateful subscriber!

Sharon Wakefield, G.G.
Northwest Gem Lab
Boise, Idaho

Reply: We thank Sharon for her kind letter, and we are pleased to announce that the online version of the *Twenty Year Index* (go to www.gia.edu/gandg, then click on "*G&G Indexes*") has been updated through the 2002 volume year. Although time constraints currently prevent us from updating the online index with each issue, we will continue to update it on an annual basis, to coincide with the publication of each Winter issue.

Brendan Laurs
Editor, *Gems & Gemology*

Hornbill "Ivory" Identification Questionable

I have several observations on the "Hornbill 'Ivory'" entry in the Winter 2001 Lab Notes section (p. 323). I feel what you have described is a misidentification, and I will give you my reasons.

Since the early 1990s, I have specialized in ivory identification (the nondestructive testing of ivory and its look-alikes). I co-founded the International Ivory Society (IIS) in 1996. In late November 2001, the owner of the bead, also a member of the IIS, sent it to me for examination (with two other beads of similar composition). It was accompanied by a GIA Gem Trade Laboratory report that I assume was prepared concurrently with the Lab Notes entry. The owner did not think the bead was hornbill "ivory" and wanted my opinion.

The helmeted hornbill has a solid tombstone-shaped casque (the large protuberance covering a portion of the head and beak) that may be up to approximately 3" × 2" × 1" in size. It is a yellowish material with a unique thin brownish-red coating on the top and two sides. I have compared this bead to hornbill examples in my collection, including a full skull of the bird, and there is no way that it could be hornbill "ivory." It has entirely too much red for its size, and the swirled structure is not found in hornbill. If a bead were cut from hornbill "ivory," the finish would have been smooth all over and not—as described—with fibrous areas. Of all of the hornbill "ivory" that I have examined, none shows this marbled appearance, nor do I or other ivory experts I have consulted believe it is capable of doing so. Such material is always opaque and only thin sections are translucent. The "carmine" color is usually limited to isolated small areas and certainly does not appear on all sides of a piece as seen in this bead.

The "burnt hair" odor that emanates when the bead is touched with a thermal reaction tester is the same in any object made of keratin, and could be mistaken for the faint dentine (ivory) odor experienced in a mammal tooth or tusk. The refractive index reading is of no help, as all "organics" have similar R.I.'s of about 1.54. Without a good polish, a good reading can rarely be obtained in any case. Further, there is no mention of any testing for dye. I don't see how GIA could have made a positive identification from the information given in this entry.

After much research, contemplation, and consultation with other ivory experts, such as Eliot Landau and Dennis Caselli (a dentist and IIS member), I have come to the conclusion that the bead is carved from an abnormal growth area in the pulp cavity of a mammal tooth or tusk that has been dyed with cochineal (a red dye). Similar objects, a type of Japanese *ojime* bead, are known as *kibatama*. An example quite similar to this bead can be seen in the

Spring 1987 issue of *Ornament* magazine (see R. K. Liu, "Material in ancient and ethnic jewelry from past issues," Vol. 10, No. 3, pp. 30–35; this article also has a photo of a hornbill bead, and both are reproduced in figure 1). These anomalies form in the pulp cavity as a rapid buildup of nodule-like secondary dentine, possibly caused by an irritant. I have seen this condition in both sperm whale and elephant ivory, and I am sure that it could form in the pulp cavity of any mammal tooth or tusk.

William R. "Bobby" Mann, G.G., P.G.
Temple Hills, Maryland
mannivorymann@aol.com

Reply: We thank Mr. Mann for his thoughtful comments regarding the Winter 2001 Lab Note entry on the purported hornbill "ivory" bead. After careful review of our observations and the literature on hornbill ivory, as well as discussion with outside experts, we have come to realize that we did not have sufficient evidence to prove conclusively that the bead had been carved from the casque of a hornbill. Therefore, the GIA Gem Trade Laboratory is issuing a new report to our client indicating that the exact origin of the

bead remains uncertain. As a matter of clarification, our standard gemological tests did not reveal any evidence of dye. Although another alternative is that this is a dentine or similar material, we were unable to confirm Mr. Mann's identification. Again, we appreciate Mr. Mann's bringing his observations to our attention.

Karin N. Hurwit
GIA Gem Trade Laboratory, Carlsbad



Figure 1. On the left is a kibatama ojime bead carved from a mammal tooth; on the right is a hornbill "ivory" ojime. Photos by Robert K. Liu, courtesy of and © 1977 *Ornament* magazine.

IN MEMORIAM

Charles W. ("Chuck") Fryer (1928–2003)

Gems & Gemology mourns the loss of distinguished gemologist Chuck Fryer, who passed away January 3 in Los Angeles at the age of 74. A highly respected leader in the GIA Gem Trade Laboratory, Chuck was a beloved member of the *G&G* family for more than 20 years.

Chuck joined GIA in 1966 and served for 14 years as director of the GIA Gem Trade Laboratory, first in Los Angeles and then in Santa Monica, before retiring as director of gem identification in 1993.

A native of Missouri, Chuck had a lifelong interest in gems and minerals. After completing his service in the U.S. Army in 1952, he relocated to San Diego, California, and enrolled in GIA through home study. He earned his Graduate Gemologist diploma from GIA in 1963 and received his F.G.A. diploma (with distinction) the same year. He attended San Diego City College from 1963 to 1966 while managing a local business that sold jewelers' supplies, lapidary equipment, and gems. As a charter member and president of the San Diego Gemological Society during those years, Chuck presented lectures and helped spread gemology in the area.

Throughout his 27-year career with GIA, Chuck Fryer was recognized as one of the world's most knowledgeable gemologists. His articles on gem identification appeared in *Gems & Gemology*, *Journal of Gemmology*, and

Jewelers' Circular-Keystone. In fact, he co-authored two past winners of the *Gems & Gemology* Most Valuable Article Award: "A Simple Procedure to Separate Natural from Synthetic Amethyst on the Basis of Twinning" (Fall 1986) and "The Characteristics and Identification of Filled Diamonds" (Summer 1989). A noted speaker, Chuck also appeared as an expert witness in court cases throughout the United States.

In addition to his 17 years as editor of the Gem Trade Lab Notes section (from 1981 to 1997) and 22 years as a member of the Editorial Review Board, Chuck performed an invaluable service the last several years as a consultant to *G&G*. He meticulously read the page proofs of every issue before it went to press, using his experience and expertise to catch the errors that reviewers, authors, and other editors had overlooked.

Chuck was a man of many pursuits. In addition to being an accomplished lapidary, he enjoyed travel, sailing, and golf.

Chuck Fryer is survived by his wife, Jan; his daughter, Kahlee Brighton; three sons, Michael, Russell, and Fraser Macfarlane; and six grandchildren. Chuck leaves behind countless friends in the field of gemology, which he served so brilliantly for more than four decades. We will miss him deeply.



CHART OF COMMERCIALY AVAILABLE GEM TREATMENTS

Christopher P. Smith and Shane F. McClure

This chart combines a comprehensive listing of the commercially available treatments for the most commonly used gem materials with an indication of the current status of their detectability. Designed as a supplement to "Gemstone Enhancement and Detection in the 1990s," from the Winter 2000 issue of *Gems & Gemology*, this chart makes the key information available in an easy-to-use reference tool.

For many centuries, a wide variety of techniques have been used to improve the appearance of gems. Early treatments typically involved changing the perceived color of stones through simple methods such as dyeing, painting, or backing them with a thin layer of foil. However, as time progressed, so did the sophistication of gem treatments. Today, there exist a vast array of methods to modify the appearance and/or properties of most gem materials (see figure 1), from rudimentary procedures such as dyeing to "high-tech" processes such as the high pressure/high temperature annealing of diamonds (Hall and Moses, 2001a,b).

Although many of the most common treatments can be identified with basic gemological training, experience, and equipment, more and more of the treatments entering the marketplace can only be detected with sophisticated analytical instruments and highly specialized expertise. It is also important that the gem and jewelry trade recognize that not all treatments are currently detectable. This is typically because of the nature of the treatment or the gem material, or a combination of the two. There are also treatments that are detectable in some cases and not in others.

This chart has been compiled to summarize the full range of treatments that may be encountered in the most common gem materials. Mentioned for each gem material are the changes that typically take

place, as well as the treatment's current detectability.

A comprehensive discussion of the various treatments encountered in the gem and jewelry trade was provided in McClure and Smith (2000). This chart is intended to complement that original publication by condensing the information found therein into a more concise, easy-to-use reference tool. For more specific information regarding the detection or development of certain treatments, the reader is referred to that article. Note, however, that the chart also includes information relating to new treatments that have emerged in the last two years. References to these additional treatments, as discussed below, are provided at the end of this article. References listed in McClure and Smith (2000) will not be repeated here.

CHART CONTENTS

Although almost any gem material can be treated in some fashion, in general there are relatively few types of treatments. The following classifications, listed at the top of the chart, represent the most frequently encountered treatments in the gem and jewelry trade

See end of article for About the Authors and Acknowledgments.
GEMS & GEMOLOGY, Vol. 38, No. 4, pp. 294–300.
© 2002 Gemological Institute of America

Figure 1. Many methods are now used to enhance gems.

Illustrated here are, from left to right, starting at the top: (row 1) 5.66 ct clarity-enhanced emerald, 10.60 ct heated amber, 3.44 ct plastic-impregnated opal; (row 2) 4.48 ct “diffusion-treated” topaz, 2.51 ct irradiated pink tourmaline, 2.14 ct Ti-diffused sapphire; (row 3) 3.73 ct coated pink topaz, 0.92 ct thermally enhanced tanzanite, 1.29 ct Be-diffused yellow sapphire, 0.94 ct Be-diffused pink sapphire; (row 4) 1.03 ct clarity-enhanced diamond, 2.06 ct thermally enhanced ruby, 0.77 ct Be-diffused ruby. Photo © GIA and Harold © Erica Van Pelt.



today. Also addressed here and at the top of the chart are key methods of detecting these treatments.

Dyeing. This treatment consists of the introduction of a colored substance into gem materials that have either a porous structure (such as agate or turquoise) or surface-reaching fractures (such as quartz or corundum), to modify their color appearance.

Detection: In most gem materials, dyeing is readily detectable with magnification, sometimes in combination with a diffused light source. Concentrations of color are often present along surface-reaching fractures or within areas of a porous structure. In some instances, gems may be dyed to hues that do not exist in nature, which alone proves the presence of dye (such as with agate). However, in some gem materials that are structurally porous (such as coral, jade, or turquoise), dyeing may not always be detectable. For other gem materials (such as gray to black or “golden” pearls) more advanced analytical techniques such as energy-dispersive X-ray fluorescence (EDXRF), UV-Vis-NIR, or Raman spectrometry may be necessary (Elen, 2001, 2002). In addition, dyeing of some gem materials may be detectable with certain dyes and undetectable with others. For example, dyed green jadeite usually can be detected with a handheld spectroscope. However, most other colors of dyed jadeite, such as lavender, black, brown, and yellow, may not be detectable at all.

Chemical Bleaching. This treatment involves the use of chemicals to lighten or whiten the color of some gem materials, as well as to remove unwanted or uneven coloration.

Detection: Typically this form of enhancement is not detectable, even though it is commonly applied to several gem materials, such as coral, ivory, jade, and pearls. One exception to this general rule is jadeite, where the effects of the bleaching process on the granular structure of the jade may be detected with magnification.

Surface Coating. This treatment may have a variety of desired results, depending on the material that is applied. These include: (A) the application of a colored substance to all or part of the surface of a gem to induce or modify the color appearance; (B) the application of a metallic substance to produce iridescence on the surface; (C) coating with a wax or plastic to improve the surface luster or durability of the gem.

Detection: Surface coatings are most readily identified with magnification, by the presence of features such as scratches, areas at facet junctions where the coatings have been worn off, and tiny bubbles trapped in the coating. Metallic/iridescent coatings are readily recognized because the appearance they create does not occur naturally.

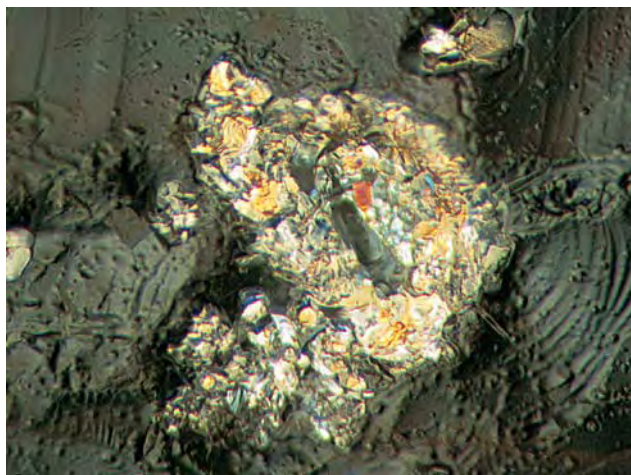
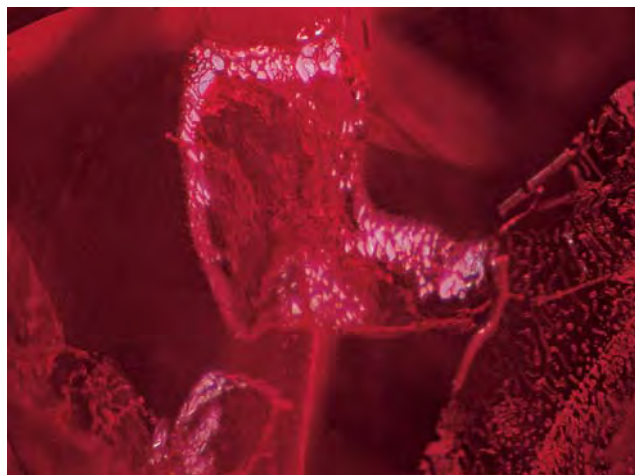

Figure 2. When rubies or sapphires are exposed to high temperatures, especially in the presence of a flux, synthetic corundum may be deposited on the surface of the gems. As shown on the left (magnified 33 \times), platelets of synthetic corundum have formed on the surface of a rough sapphire that has been treated by a Be-diffusion process. On the right (magnified 40 \times), small platelets of synthetic corundum can be seen lining the bottom of a glass-filled cavity in a Mong Hsu ruby. Photomicrographs by Shane F. McClure.

Impregnation. In this treatment, voids within a porous gem material are filled with a wax or polymer to improve the gem's durability, luster, transparency, or color appearance.

Detection: Typically, wax impregnation may be detected with the use of a "hot point" and magnification. Infrared or Raman spectrometry will readily identify polymer as well as wax impregnation.

Thermal Enhancement. Heat is applied to many gem materials to modify their color and/or clarity. Some gems may need only "low temperature" (e.g., less than 1,000°C) heating to achieve the desired results, while others require higher temperatures. In addition, some gem varieties (such as ruby and sapphire) may be exposed to either low- or high-temperature heating, and other gems (such as diamond) may be exposed to high pressure in conjunction with high temperature (HPHT).

For the vast majority of the gem materials treated in this manner, the application of heat is intended to improve their color. In the case of rubies and sapphires, heat is also applied to improve their transparency by dissolving rutile inclusions. In addition, corundum may be heated to facilitate the healing of fractures, either with or without chemical additives ("The Gübelin Gem Lab introduces . . .," 2000). Another effect of exposing rubies or sapphires to high temperatures, particularly when a flux is used, is the deposition of synthetic corundum on the surface of the gems (McClure, 2002; "Further characterization . . .," 2002; see figure 2). The heat-

ing process also often leads to the production of glass-like materials that can fill cavities and surface-reaching fractures in some rubies.

Detection: In corundum, heating is routinely detected by the presence of thermally altered inclusions (such as strongly altered crystals or healed fractures) or modified color concentrations (such as the spotty coloration of some heated blue sapphires), which are observed with magnification. For certain gems (such as some ruby, sapphire, or pink topaz), ultraviolet fluorescence may also provide an indication of thermal enhancement. However, there are still a number of gems (such as quartz, tourmaline, and tanzanite [zoisite]), where the color is modified homogeneously and there are few inclusion features present to indicate exposure to elevated temperatures. The heat treatment of such gems is typically undetectable or in some instances requires more advanced analytical techniques (such as UV-Vis-NIR or Raman spectrometry). Additionally, there are some gem species (such as corundum or diamond) where the detection of heating is possible in most cases, but not in all.

Diffusion Treatment. Today, we understand more fully that virtually all types of thermal enhancement involve some form of diffusion. The term *diffusion* refers to the movement of atoms or defects within the crystal lattice of a gem. The movement of pre-existing atoms is what makes thermal enhancement work (this phenomenon is referred to as *internal diffusion*). *Diffusion treatment* refers to the introduction of color-causing atoms from an outside source

that then enter and move through the gem. When this movement is only at the surface, it is referred to as *surface diffusion*. If the movement is into the body of the stone, whether it is shallow or permeates the entire gem, it is properly called *bulk* or *lattice diffusion* (Emmett and Douthit, 2002b). It is important to note here that the historical use of the term *surface diffusion* in gemology is incorrect (Kizilyalli et al., 1999).

Many elements may be diffused into the lattice of a gem from an external source in order to produce color or create asterism. These include light elements such as beryllium (Be), or elements further down the periodic table such as titanium or chromium.

Detection: When heavier elements are diffused into a gemstone from an external source, the treatment is readily detected with magnification and immersion by the very shallow color penetration that results, as well as—with EDXRF or scanning electron microscopy–energy-dispersive spectrometry (SEM-EDS)—by the elevated concentrations of the diffused elements.

When light elements are used, the treatment may be less readily detectable, since the penetration of the diffused color may extend homogeneously throughout the stone and the color-causing elements may not be revealed by standard chemical analysis.

If the induced color does not permeate the entire stone, then the fact that it is surface related may be observable with magnification and immersion, providing a clear indication of diffusion treatment (Moses, 2002). Also, because the diffusion of some light elements into corundum requires extremely high temperatures, inclusions in stones subjected to

this form of treatment show much greater damage than is seen in stones exposed to lower temperatures (figure 3).

Elevated concentrations of some color-causing elements lighter than the transitional elements, such as calcium, can be detected with routine chemical analysis (e.g., EDXRF); SEM-EDS can extend this capability down to boron. However, lighter elements such as Be or lithium can be detected only with more sensitive, less readily available analytical techniques such as laser ablation–inductively coupled plasma–mass spectrometry (LA-ICP-MS) or secondary ion mass spectrometry (SIMS), as described in McClure et al. (2002b).

Irradiation. The color of many gem materials can be altered by exposing them to various forms of radiation, such as electrons, gamma rays, or neutrons. The radiation can cause defects in the crystal lattice, called color centers. The resultant coloration may be shallow or extend throughout the gemstone, and in some cases it is unstable to heat and/or light (McClure et al., 2001).

Detection: This form of treatment is difficult or impossible to identify in most gems. In those situations where it can be detected, more advanced techniques (such as UV-Vis-NIR or Raman photoluminescence spectrometry) are usually required. However, this treatment can be detected in some gem materials without these advanced techniques, such as in diamonds that have colors not seen in natural stones, or that display characteristic color concentrations because they have been exposed to specific sources of radiation (fast electrons, radium salts, or a cyclotron reactor), as illustrated in figure 4.



Figure 3. The new Be-diffusion process exposes corundum to such high temperatures that extreme changes occur in the inclusions, such as: (left) partial recrystallization of melted inclusions, (center) completely melted inclusions that contain gas bubbles, and (right) large spherical blue halos around rutile crystals. Photomicrographs by Shane F. McClure (left and center, magnified 40 \times) and John I. Koivula (right, magnified 25 \times).



Figure 4. The color zoning characteristic of cyclotron irradiation in diamond follows the crown facets at a shallow depth below the surface of the stone. Photograph by Robert E. Kane; magnified 40×.

Clarity Enhancement. This treatment involves introducing a liquid, semi-solid, or solid substance (such as oil, wax, resin, polymer, or glass) into surface-reaching fractures to reduce their visibility, thereby improving the apparent clarity of the gem. It is important to note that this treatment can be applied to almost any gem material; the chart lists only those gems in which this treatment is most commonly encountered.

Detection: Clarity enhancement usually is readily detectable with magnification and a little experience. However, when the refractive index of the filler is close to that of the host gem, and a large number of other types of inherent inclusions are present, detection may require closer scrutiny of the sample in a variety of viewing directions. In many instances, a “flash effect” is noted when the stone is viewed in a direction roughly parallel to a filled fracture. Gas bubbles trapped in an incompletely filled fracture or flow structures within the filler are also commonly observed.

Other Treatments. There are some treatments that are more or less individualized for certain gems. Examples include: “reconstructed” amber, in which smaller pieces of amber are combined to form larger pieces; laser drilling of diamonds, whereby a laser is used to create a path from a black inclusion to the surface of the diamond, which then serves as a conduit for chemical bleaching to “whiten” the inclusion; and a proprietary treatment to reduce the porosity and sometimes enhance the color of

turquoise, known as the “Zachery treatment.”

In this chart, the term *staining* (as used with ivory) is applied to describe the introduction or augmentation of an artistic design, as opposed to *dyeing*, which is used when the “body color” of a gem material has been altered. It must also be kept in mind that two or more types of treatment may be combined to create a result different from that produced by any of the techniques used alone. One example is the use of irradiation followed by heating to further modify color in diamond and topaz.

CHART ORGANIZATION

As stated above, this chart details the commercially available treatments that are applied to the most common types of gem materials. The upper one-third summarizes the most frequently encountered treatment classifications, as described in the first part of this article, including general comments relating to their detection; three images accompany each treatment type, illustrating the treatment results or visible clues to its detection. In the lower two-thirds of the chart, the individual gem materials are organized in five columns alphabetically from the upper left to the lower right. Gems are presented under their species or group name, as opposed to the variety, because many treatments alter the variety classification. Also included are amber, Ammolite, coral, ivory, and pearl.

Listed for each gem material are the types of treatments most often applied, with a brief description of the purpose or result of the treatment. It is important to note that the same type of treatment may achieve a wide range of results. Therefore, the chart presents only the most typical results for a particular treatment type.

At the end of each description is a letter code that indicates the current detectability for the specific type of treatment:

(D) – Those treatments that are routinely *detectable* using visual observation and/or standard gemological instrumentation.

(D+) – Those treatments that are *detectable but require advanced analytical techniques* that typically are not available to most gemologists.

(NAD) – Those treatments that are *not always detectable*. Depending on the type of gem material and the recorded properties, it is not always possible to detect some treatments in all cases.

(ND) – Those treatments that currently are *not detectable*.

In most cases, treatment types vary in terms of their detectability, both from one gem material to another and even among varieties within a gem material. Depending on the intended results, certain treatments may be more readily detected than others. For this reason, more than one detection code may be noted under an individual gem material and/or treatment type. One such example is Diamond/Irradiation, where three detection codes are indicated. This is because, depending on the type of radiation used, irradiated diamonds may be readily detectable (**D**), detectable but only with more advanced analytical techniques (**D+**), or even currently not detectable (**ND**). The identification of a treatment depends heavily on the gem material being treated, the type of treatment applied, and the properties that result after treatment.

Macro photographs, including some “before-and-after” treatment images, and photomicrographs of identifying features accompany most entries. These images are designated by letters for the top section and numbers for the bottom section. They are referenced by these letters and numbers to the specific treatment or gem material to which they apply.

This chart does not present all treatments or treatment results that are possible for any particular gem material. There are some gem materials that have been treated experimentally by a variety of means, but are not commercially available. There are also instances where the end result of a commercially available treatment may be atypical and rarely seen (see, e.g., figure 5). Although some basic guidelines concerning the identification of the most readily detectable types of treatments are provided, this chart is not intended to summarize *all* the criteria that are currently applied to detect *all* the various gem materials and accompanying treatments described herein. For further information on the identification of such treatments and the instrumentation used, the reader is referred to McClure and Smith (2000), as well as (for the newer treatments) to the references given in this article.

COMMENTS ON DISCLOSURE

Although this article is not intended to delve into the many aspects of proper disclosure of gem treatments, it is prudent that a few comments be made. Gems that have been manipulated in one fashion or another to modify or enhance their appearance are now a permanent part of our industry. In some cases, treatment has become so commonplace that

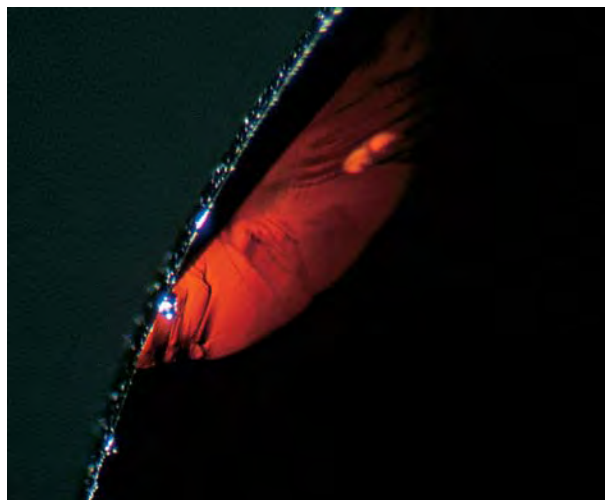

Figure 5. Irradiated black diamonds typically appear very dark green with a strong light source. However, we have on occasion seen treated black diamonds that were actually very dark orange, resulting from the annealing of irradiated, very dark green stones. Photomicrograph by Shane F. McClure; magnified 40 \times .

the enhanced gem is more available in the marketplace than its nonenhanced equivalent (e.g., tanzanite, aquamarine, and citrine). Additionally, in some instances it was only through the application of a particular treatment that generally “more attractive” gems became available to the trade and consumers than would have been possible without the treatment (e.g., rubies and emeralds).

We also do not intend to suggest which treatments should be considered “acceptable” or “not acceptable.” We believe that every type of gem material, untreated as well as treated, has a place in the gem and jewelry market. However, it is absolutely essential that all parties within the producing, wholesale, and retail sectors of the jewelry trade recognize that disclosure is vital to the welfare of the industry. Therefore, they must continually educate themselves on the availability, results, and identification of such treatments so that they can in turn properly inform their customers.

CONCLUSION

The topic of gemstone treatments, and their detection and disclosure, continues to be one of the most important issues facing our industry. Indeed, since our summary of gemstone treatments of the 1990s was published in the Winter 2000 issue, two major new treatment techniques with far-reaching implications for the gem and jewelry industry reached the market: new developments in the laser

treatment of diamonds (Cracco and Kaban, 2002), and diffusion of beryllium into sapphire (McClure et al., 2002a, b; "Orange-pink sapphire...", 2002; Emmett and Douthit, 2002a,b). Other new treatments continue to emerge, such as synthetic ruby overgrowth on natural corundum (Smith, 2002). Before gem dealers or jewelry retailers can adopt a policy of proper disclosure, they must first educate themselves about the multitude of gem materials and treatments that are currently commercially

available. This chart was specifically designed to summarize this information for those in our trade.

One of the key features of this chart is that it provides, for the first time, a detailed listing of the current state of detectability of certain treatments in specific gems. Most importantly, this includes the many instances where treatments are currently not detectable or not always detectable, or where they can only be determined with advanced instrumentation.

ABOUT THE AUTHORS

Mr. Smith is managing director of the Gübelin Gem Lab Ltd. in Lucerne, Switzerland. Mr. McClure is director of West Coast Identification Services at the GIA Gem Trade Laboratory, Carlsbad, California.

ACKNOWLEDGMENTS: The authors thank Tom Moses and John Koivula (of the GIA Gem Trade Laboratory, New York and Carlsbad) and John Emmett (of Crystal Chemistry, Brush Prairie, Washington) for valuable input, as well as Dr. Karl Schmetzer for reviewing various versions of the chart. Several people kindly loaned gems for examination and/or

photography. These include (all figure references are to the chart): Pierre Paré of Korite International, Calgary, Alberta, Canada, for the untreated and impregnated halves of Ammolite (figures 3 and 4); Roland Naftule of Nafco Gems, Scottsdale, Arizona, for the Be-diffused sapphire (figure 23); Evan Caplan of Omi Gems, Los Angeles, for the blue zircon (figure 67); Jeffrey Post of the Smithsonian Institution, Washington, DC, for the red zircon (figure 68); and Steve Ulatowski of New Era Gems, Grass Valley, California, for the before-and-after sample of tanzanite (figure 70). Karen Myers, art director of Gems & Gemology, is responsible for design and production of the chart.

REFERENCES

- Cracco V., Kaban H. (2002) Gem Trade Lab Notes: Internal laser drilling update. *Gems & Gemology*, Vol. 38, No. 2, pp. 164–165.
- Elen S. (2001) Spectral reflectance and fluorescence characteristics of natural-color and heat-treated "golden" South Sea cultured pearls. *Gems & Gemology*, Vol. 37, No. 2, pp. 114–123.
- Elen S. (2002) Update on the identification of treated "golden" South Sea cultured pearls. *Gems & Gemology*, Vol. 38, No. 2, pp. 156–159.
- Emmett J.L., Douthit T.R. (2002a) Beryllium diffusion coloration of sapphire: A summary of ongoing experiments. American Gem Trade Association, issued September 4, <http://agta.org/consumer/gtclab/treatedsapps04.htm> [accessed November 26, 2002].
- Emmett J.L., Douthit T.R. (2002b) Understanding the new treated pink-orange sapphires. Pala International, http://palagems.com/treated_sapphire_emmett.htm [accessed November 26, 2002].
- Further characterization of sapphires recently treated in Bangkok (2002) American Gem Trade Association, issued April 19, <http://agta.org/consumer/gtclab/treatedsapps01.htm> [accessed November 26, 2002].
- The Gübelin Gem Lab introduces a new thermal enhancement scale for corundum (2000) Gübelin Gem Lab Ltd., issued August 25, <http://www.gubelinlab.com> [accessed November 26, 2002].
- Hall M., Moses T. (2001a) Gem Trade Lab Notes: Heat-treated black diamond: before and after. *Gems & Gemology*, Vol. 37, No. 3, p. 214–215.
- Hall M., Moses T. (2001b) Gem Trade Lab Notes: Update on blue and pink HPHT-annealed diamonds. *Gems & Gemology*, Vol. 37, No. 3, pp. 215–216.
- Kizilyalli M., Corish J., Metselaar R. (1999) Definitions of terms for diffusion in the solid state. *Pure and Applied Chemistry*, Vol. 71, No. 7, pp. 1307–1325.
- McClure S.F. (2002) Gem Trade Lab Notes: Bulk diffusion-treated sapphire with synthetic overgrowth. *Gems & Gemology*, Vol. 38, No. 3, pp. 255–256.
- McClure S.F., Smith C.P. (2000) Gemstone enhancement and detection in the 1990s. *Gems & Gemology*, Vol. 36, No. 4, pp. 336–359.
- McClure S.F., Moses T., Koivula J.I. (2001) Gem News International: U.S. Postal Service irradiation process may affect some gemstones. *Gems & Gemology*, Vol. 37, No. 4, pp. 326–328.
- McClure S., Moses T., Koivula J.I., Wang W. (2002a) A new corundum treatment from Thailand. Gemological Institute of America, issued January 28, http://www.gia.edu/wd_2798ar_45aris_21.htm [accessed November 26, 2002].
- McClure S.F., Moses T., Wang W., Hall M., Koivula J.I. (2002b) Gem News International: A new corundum treatment from Thailand. *Gems & Gemology*, Vol. 38, No. 1, pp. 86–90.
- Moses T. (2002) Gem Trade Lab Notes: Sapphire—bulk or lattice diffusion treated. *Gems & Gemology*, Vol. 38, No. 3, pp. 254–255.
- Orange-pink sapphire alert (2002) American Gem Trade Association, issued January 8, <http://agta.org/consumer/gtclab/orangesapphirealert.htm> [accessed November 26, 2002].
- Smith C.P. (2002) "Diffusion ruby" proves to be synthetic ruby overgrowth on natural corundum. *Gems & Gemology*, Vol. 38, No. 3, pp. 240–248.

GEMESIS LABORATORY-CREATED DIAMONDS

By James E. Shigley, Reza Abbaschian, and Carter Clarke

High-quality yellow, orange-yellow, and yellow-orange laboratory-created type Ib diamond crystals up to 3.5 ct are being produced commercially by the Gemesis Corp. of Sarasota, Florida. In some samples, color zoning (yellow and narrower colorless zones) and a weak UV fluorescence pattern (a small green cross-shaped zone combined with an overall weak orange luminescence) provide means of identification; when present, metallic inclusions also indicate laboratory growth. Some samples lack these diagnostic visual features, but all of these Gemesis synthetic diamonds can be identified by advanced instrumentation such as the De Beers DiamondView luminescence imaging system and EDXRF chemical analysis.

The possibility of high-quality synthetic diamonds being produced for jewelry purposes, and the potential for their misidentification, have concerned members of the jewelry trade since General Electric produced the first synthetic diamonds in 1954 (Strong and Wentorf, 1991). Such apprehensions have overshadowed the fact that only a very small number of gem-quality synthetic diamonds have entered the marketplace (approximately 1,000 carats annually). In spite of their limited availability, synthetic diamonds have been studied extensively, and the means to distinguish them from natural diamonds have been widely publicized (see, e.g., Crowningshield, 1971; Koivula and Fryer, 1984; Shigley et al., 1993a,b, 1995). To date, large-scale commercial production of synthetic diamonds for jewelry use has not been fully achieved.

This situation is beginning to change with the expansion of production capacity for high-quality yellow laboratory-grown diamonds by the Gemesis Corp. (figure 1). Using "BARS" diamond-growth equipment and expert Russian technicians, and with technical assistance from scientists and engineers at the University of Florida, this company redesigned the growth apparatus, commercialized the production process, and established a pilot plant in Gainesville, Florida. To accommodate expansion

plans, the company has constructed a new 30,000 square foot (2,788 m²) production facility in Sarasota, Florida. Over the next few years, this facility could be expanded to include more than 300 "BARS" units.

This article describes efforts by Gemesis to grow commercial quantities of 2.5–3.5 ct yellow synthetic diamond crystals with consistent color, quality, and yield (see also Attrino, 1999; Lerner, 2002). The company's goal is to achieve a production level at which 90% of their crystals are suitable for manufacturing as polished gems of 1 ct or larger. At present, there are no plans to produce crystals that would cut smaller or melee-size (<0.20 ct) material. Marketing efforts have initially focused on selected jewelry manufacturers and retailers, and the company advocates complete disclosure to jewelers and consumers.

Although development of equipment that will grow even larger sizes is under consideration, as are efforts to grow colorless and blue synthetic diamonds on a commercial scale, this article will focus on the yellow (including orange-yellow and yellow-orange) crystals now being grown by Gemesis, and

See end of article for About the Authors and Acknowledgments.
GEMS & GEMOLOGY, Vol. 38, No. 4, pp. 301–309.
© 2002 Gemological Institute of America

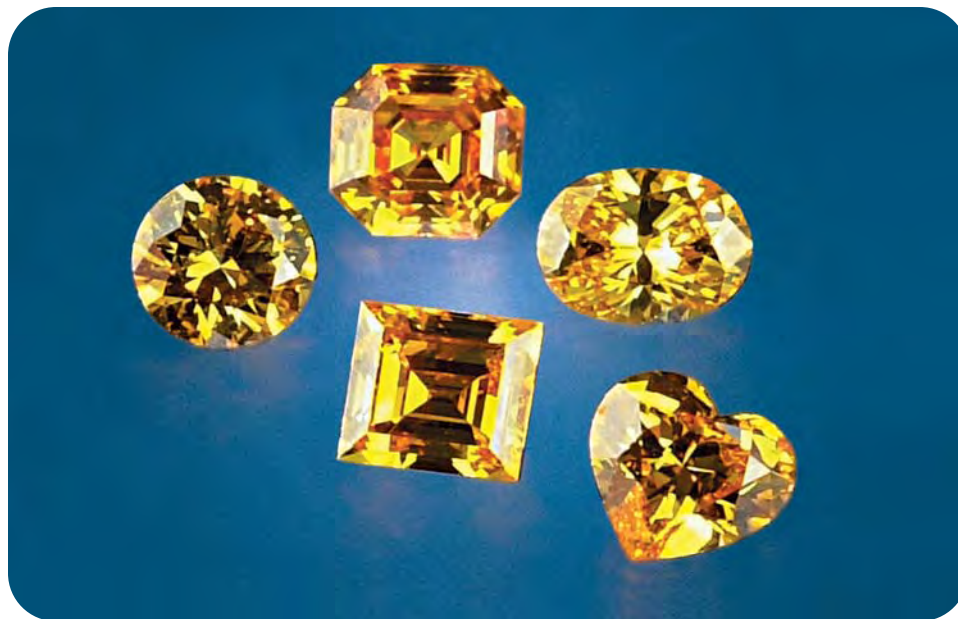

Figure 1. These five laboratory-created diamonds (0.80 to 1.25 ct) are representative of the material now being produced commercially by the Gemesis Corp. Photo by Elizabeth Schrader.

the means by which they can be identified with standard gemological techniques and, if necessary, advanced instrumentation.

“BARS” GROWTH OF SYNTHETIC DIAMONDS

Gemesis technicians use a redesigned and re-engineered split-sphere (“BARS”) apparatus, as illustrated in figure 2 (for information on this equipment, see Palyanov et al., 1990, 1997, 1998; and Shigley et al., 1993b). With this type of apparatus, pressure is applied to the growth chamber (which measures approximately 2.5 cm on a side) by a series of anvils machined from carbide steel and composites. An inner set of six anvils, positioned perpendicular to the sides of a cube, surrounds the growth chamber. An outer set of eight anvils, positioned perpendicular to the sides of an octahedron, surrounds the inner set. This entire multi-anvil arrangement is housed within two hemispherical steel castings (which are hinged to allow access to the anvils and growth chamber; thus the name “split sphere”). Two large steel clamps keep these castings together. Pressure is applied hydraulically against the curved outer surfaces of the eight anvils. A graphite element is used to heat the chamber.

Typical diamond growth conditions with this equipment are pressures of 5.0 to 6.5 Gigapascals (GPa, equal to 50 to 65 kilobars) and temperatures of 1,350° to 1,800°C. Various transition metals (such as iron, nickel, and cobalt) provide a solvent and catalyst medium. Growth takes place on a tiny seed crystal, which can be either natural or synthetic diamond. The orientation of the seed determines the

shape and geometry of the grown crystal. There is a small but important difference in temperature between the top of the growth chamber (the “hotter” end, where the carbon source material is located) and the bottom (the “cooler” end, where the seed crystal is located). This difference provides the driving force for diamond crystallization (hence, the growth method is called the “temperature gradient” technique; see Strong and Chrenko, 1971; Strong and Wentorf, 1971; Wentorf, 1971). Powdered graphite dissolves in the molten metal solvent in the hotter portion of the chamber; the carbon atoms move through the solvent under the influence of the temperature gradient and crystallize as a single diamond crystal on the seed in the “cooler” part of the chamber. Powdered diamond also can be used as a carbon source material.

PRODUCTION AT GEMESIS

Currently, Gemesis has 23 “BARS” units in operation; an additional four units are dedicated for research purposes at the University of Florida. Although using the same fundamental design as the original Russian-made units, Gemesis scientists and engineers have modified the growth equipment in several important ways to comply with American engineering standards and improve its functioning. The redesigned equipment has greater longevity and is more easily manufactured, operated, and maintained than the original units. The equipment also is relatively safe to operate, with little possibility that catastrophic failure of the pressure vessel could cause danger to operating personnel. The redesign

recognizes that one key to the commercial growth of gem-quality synthetic diamonds, in addition to the purity, consistency, and geometries of the starting materials, is careful computer monitoring of both temperature and pressure conditions to insure that steady growth conditions are maintained. Another innovation is a new mechanism to open and close the hemispherical castings, permitting easier sample loading and unloading. Eight patent disclosures have been filed with the University of Florida's Office of Technology Licensing, and have been transferred to Gemesis. Gemesis currently protects its intellectual property through trade secrets and selective disclosures, and it may seek patent protection on several proprietary aspects of its technology.

With this modified equipment, it takes approximately 80 hours to produce a single synthetic diamond crystal up to 3.5 ct. The depth of yellow color, as well as the shape, symmetry, and clarity of the crystals, can be controlled to some extent. Some multiple crystals have been grown experimentally in a single chamber during a 36-hour growth cycle, although the volume of the chamber means that these crystals must be smaller (about 0.6 ct each for four crystals in the chamber, and about 0.35 ct each for eight crystals).

Gemesis also has grown a limited number of blue and colorless synthetic diamond crystals, but it has not finalized plans for commercial production of this material. Also under consideration is the design

of equipment with a larger growth chamber in order to produce crystals up to 15 ct. Since 2000, approximately 4,000 carats have been grown, with the present capacity being around 550 carats per month.

MARKETING PLANS

In 2002, the company sold a limited quantity of both rough and polished yellow synthetic diamonds to a small number of manufacturers and retailers for use in jewelry. Future sales will be directed toward additional selected manufacturers and retailers. Prices vary depending on cutting style, color, and appearance. An external laser inscription and an internal mark are being considered as practical means of clearly disclosing the laboratory-grown identity of the material. In addition, each crystal will have a certificate of origin issued by an independent laboratory. At present, Gemesis has no plans to manufacture jewelry or use their growth equipment for the high-pressure/high-temperature treatment of their product or other diamonds to modify their color. Again, the company goal is to produce high-clarity laboratory-grown diamonds in several categories of yellow color in a consistent size and quantity that could be "made to order" for jewelry applications.

With commercial production now occurring at the expanded facility in Sarasota, and based on the success of initial sales, the company plans to install an additional 16 growth units per month beginning in mid-2003. This would result in approximately 300 units within two years in the present production facility, which has been designed to facilitate expansion to twice its current space if warranted. The company's close relationship with scientists at the University of Florida is an important part of its business plan. The current research emphasis is on optimizing growth conditions for blue diamonds and, eventually, colorless diamonds.

MATERIALS AND METHODS

We examined a total of 30 Gemesis laboratory-grown diamonds (six yellow, 11 orange-yellow, and 13 yellow-orange) that are representative of the product now being sold. These included five orange-yellow and yellow-orange crystals (1.81–2.47 ct) and 25 faceted samples (0.68–1.34 ct). Standard gemological properties were measured for these samples, and internal features were observed with a gemological microscope. Reactions to ultraviolet radiation were viewed in a darkened room with four-watt long-

Figure 2. This modified "BARS" growth apparatus, shown here in a partly opened configuration, is of the type used by Gemesis to grow synthetic diamonds. Photo by Tom Moses.

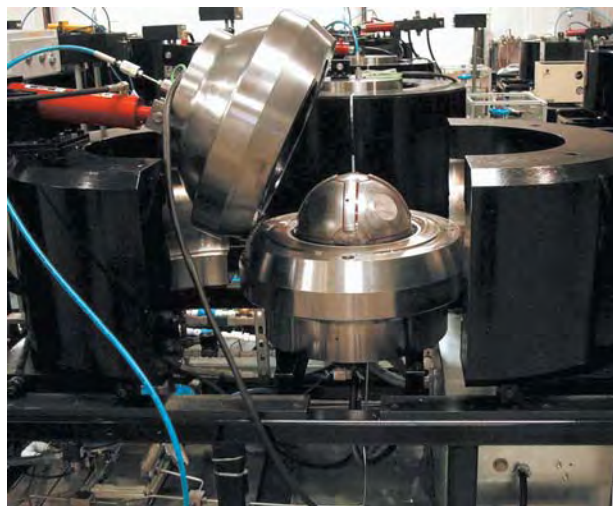



Figure 3. The 2.17 ct crystal on the left shows the cuboctahedral form typical of most synthetic diamonds grown by the temperature gradient technique. On the right, the four-fold arrangement of colorless growth sectors (and several dark metallic inclusions) can be seen in this 1.81 ct crystal. Photomicrographs by James Shigley; magnified 15× (left) and 25× (right).

wave (366 nm) and short-wave (254 nm) Ultraviolet Products lamps. Absorption spectra were observed with a desk-model Beck prism spectroscope.

Faceted samples of each of the three colors were selected for testing with advanced instrumentation. A Thermo Spectronic Unicam UV500 spectrophotometer was used to record absorption spectra of 16 samples held in a cryogenic cell cooled by liquid nitrogen over the range of 250–850 nm with a resolution of 0.1 nm. Absorption spectra in the mid-infrared range (6000–400 cm^{-1}) and the near-infrared range (10,500–4000 cm^{-1}) were recorded for 15 samples at room temperature with a Nexus 670 Fourier-transform infrared (FTIR) spectrometer. In the mid-infrared range, the resolution was set to 1.0 cm^{-1} . In the near-infrared, the resolution was 4.0 cm^{-1} .

Photoluminescence spectra were recorded for 13 samples with a Renishaw 1000 Raman microspectrometer over a range of 520–870 nm using a 514.5

nm Argon laser operating at an initial power of 20 mW. Five summed scans were accumulated for a better signal-to-noise ratio; the samples were held in a cryogenic cell cooled by liquid nitrogen.

Qualitative chemical analyses of 19 rough and cut samples were obtained by energy-dispersive X-ray fluorescence (EDXRF) with either of two instruments. One was a Thermo-Noran Omicron system operating at accelerating voltages of 25 and 35 kV, with beam currents between 0.06 and 0.08 mA. The other was a Kevex Spectrace QuanX system operating at an accelerating voltage of 20 kV and a beam current of 0.30 mA. (The two sets of conditions used for the Omicron system were chosen to broaden the range of elements that could be detected.)

The cathodoluminescence reaction of one faceted yellow sample was observed with a Luminoscope ELM-3R cathodoluminescence (CL) unit operating at 10–15 kV and 0.5–1.0 mA. Similar reactions for 12 other faceted samples were observed with the De Beers DiamondView™ deep-UV luminescence imaging system (Welbourn et al., 1996).

Figure 4. The Gemesis synthetic diamonds are faceted to maximize color through the crown facets, minimize the visibility of any small metallic inclusions, and retain maximum weight. These four faceted samples (0.85 to 1.34 ct) represent the range of colors produced. Photo by Maha Tannous.



RESULTS AND DISCUSSION

Visual Appearance. The five crystals exhibited the cuboctahedral forms typical of synthetic diamonds grown by the temperature gradient technique. These crystals were nearly equant in dimension (figure 3), or were slightly distorted in shape (i.e., unequally developed or missing crystal faces, irregular surfaces, etc.) as a result of minor changes in conditions during a growth run. The 25 faceted samples varied from yellow-orange through orange-yellow to yellow; they were high in saturation and moderate in tone (corresponding to “Fancy Vivid” in the terminology used for natural-color diamonds; see figures 1 and 4).

Clarity. In general, the faceted samples were of good

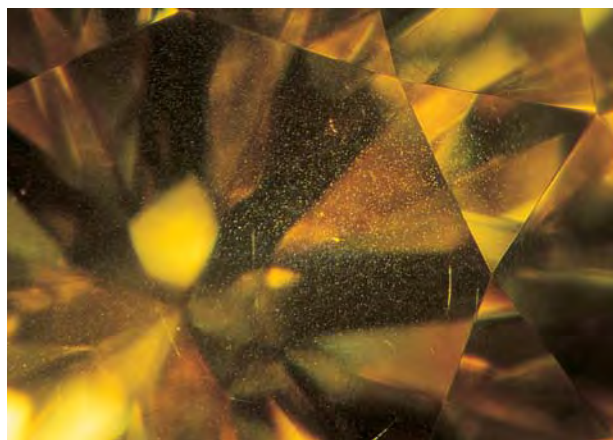

Figure 5. Small metallic inclusions were observed in 10 of the 30 Gemesis laboratory-grown diamonds, three of which are illustrated here. Note in the center image that a small area also shows part of the original crystal surface. The metallic inclusion on the right, seen in direct view and by reflection in two facets, has an equant shape with flat surfaces. Photomicrographs by James Shigley; magnified 75 \times .

clarity and relatively free of inclusions in comparison to other synthetic diamonds that we have examined. Equivalent clarity grades of the test samples would be in the VS to SI range. Ten of the faceted samples did exhibit small, opaque metallic inclusions visible with 10 \times magnification (figure 5), and the majority of the samples exhibited a cloud-like arrangement of very tiny, dispersed pinpoint inclusions (figure 6). A few samples displayed remnants of the original crystal surface that was not removed during polishing (figure 5, center).

Other Features Seen with Magnification. Although it is not readily apparent in all samples, the most common feature seen with magnification was color

Figure 6. Most of the faceted Gemesis synthetic diamonds displayed tiny pinpoint inclusions in a dispersed, cloud-like pattern that differs from the arrangement of pinpoint inclusions seen in natural type Ib yellow diamonds. Photomicrograph by Shane McClure; magnified 20 \times



zoning. When most of the polished samples were examined through the pavilion facets, larger yellow zones were seen to be separated by narrower colorless zones (figure 7). On occasion, this color zoning could even be seen through the crown facets. In two of the faceted samples, no colorless zones were evident. During manufacturing, efforts are made to reduce the visibility of these colorless zones through the crown facets by the choice of cut shape and facet arrangement. It is also possible to minimize this zoning by modifying the growth conditions.

No seed crystal was evident in any of the crystals; only a remnant of the imprint of the seed was visible on their bases. Typically the seed breaks away when the crystal is removed from the growth chamber.

Luminescence. In general, the samples displayed weaker long- or short-wave UV fluorescence than other synthetic diamonds GIA has examined; 10 were inert. In those that did fluoresce, the reaction was weak or very weak orange to both UV wavelengths. No difference in fluorescence intensity was noted between long- and short-wave UV in 11 of the samples that did fluoresce; in the remaining nine samples, the short-wave reaction was either slightly weaker or slightly stronger in intensity as compared to long-wave. In some samples (10 in long-wave and 15 in short-wave UV), a small green cross-shaped pattern was superimposed on the weak orange luminescence (figure 8). In two of the crystals, this cross-shaped pattern appeared near the center of the base where the seed had been located. Similar but more intense cross-shaped luminescence patterns could be seen in all of the samples examined by the Luminoscope CL unit

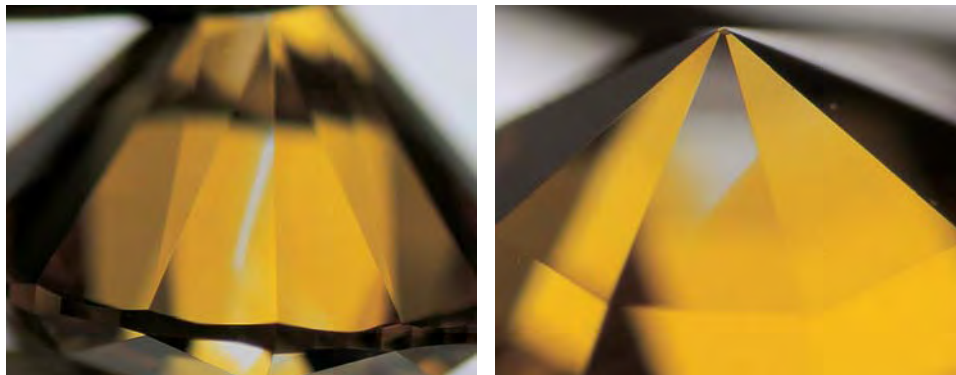
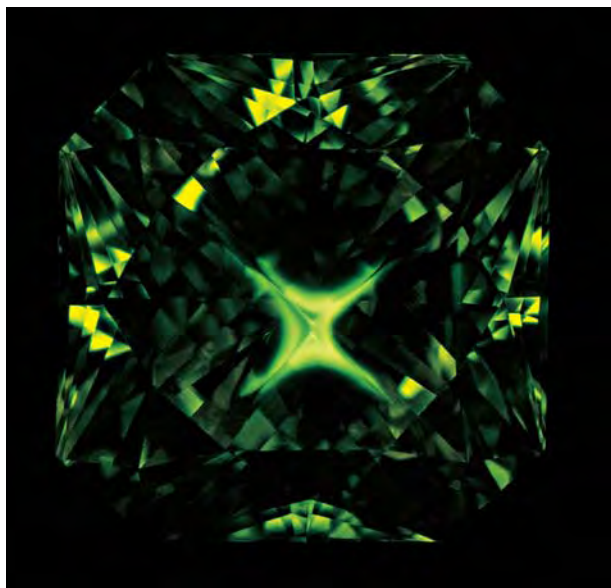

Figure 7. The narrow colorless zones in these two polished yellow Gemesis synthetic diamonds (0.80 and 0.88 ct) are diagnostic of their growth in a laboratory. Photomicrographs by James Shigley; magnified 25× (left) and 75× (right).

(figure 9) and the De Beers DiamondView (e.g., figure 10). None of the samples exhibited any phosphorescence to standard UV lamps, or any luminescence when they were illuminated with a strong light source from the desk-model spectroscope.

Visible Spectra. Using a prism spectroscope and transmitted light, we could not see any sharp absorption bands in the spectra of any of the 30 synthetic diamonds tested. There was, however, a gradual increase in absorption toward the blue end of the spectrum.

Figure 8. This 0.93 ct yellow Gemesis sample exhibits green luminescence in a cross-shaped pattern when exposed to long-wave UV radiation. Photography of this luminescence required an extended exposure time of several minutes due to its weak intensity. This fluorescence pattern is characteristic of many synthetic diamonds and has never been observed in natural stones. Photo by Shane Elen.



Information Obtained from Advanced Instrumentation. Based on their infrared spectra, all of the synthetic diamonds were type Ib (several exhibited a weak feature at 1284 cm^{-1} due to the aggregated "A" form of nitrogen [a N-N pair]; see Wilks and Wilks, 1994, pp. 68–70). There were no significant differences in the visible spectra of the samples tested that could be directly correlated to the small differences in their hues (i.e., yellow, orange-yellow, or yellow-orange). These spectra displayed increasing absorption toward the ultraviolet beginning at about 500 nm; no sharp absorption bands were noted. This kind of spectrum is typical of type Ib diamonds (natural or synthetic), which contain nitrogen, predominantly as dispersed single atoms (see Wilks and Wilks, 1994, pp. 70–73).

Figure 9. When exposed to a beam of electrons in a vacuum chamber, this 1.30 ct yellow Gemesis synthetic diamond displayed a green, cross-shaped cathodoluminescence pattern. Photo by Sam Muhlmeister.

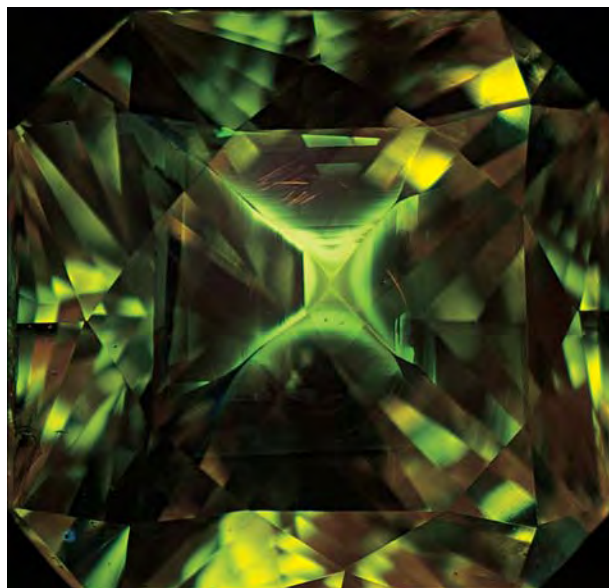
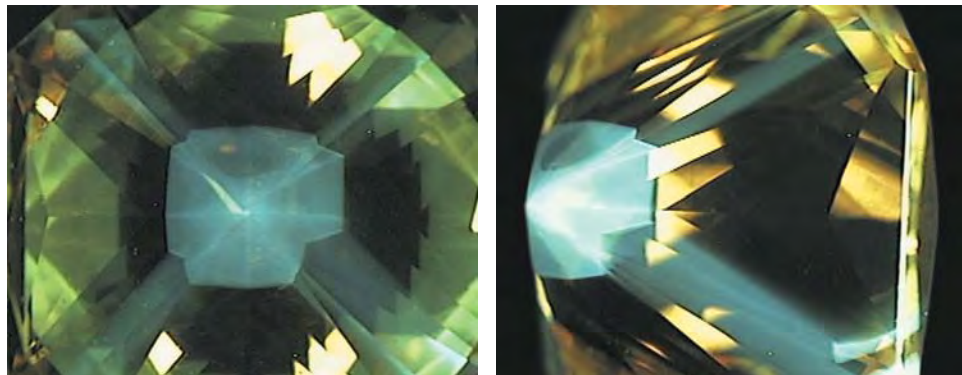

Figure 10. These two views in different orientations show the zoned luminescence pattern of a 1.30 ct Gemesis synthetic diamond as recorded with a De Beers DiamondView luminescence imaging system. Observation of this kind of pattern confirms that the sample is laboratory grown. Photos by Shane Elen.



For purposes of this discussion, the additional spectral and chemical information is organized according to the three hue categories.

Yellow. The two yellow samples on which photoluminescence (PL) spectra were taken all exhibited a single band at 1332.5 cm^{-1} , which is the first-order and characteristic Raman peak for diamonds (Wilks and Wilks, 1994, pp. 66–67); sharp peaks at 637 and 747 nm were also seen in one sample. Three of the four analyzed by EDXRF displayed no X-ray emission peaks, while one exhibited peaks due to nickel and iron. Such elements are derived from the solvent material used for crystal growth by the temperature gradient technique, and small amounts are sometimes retained within the synthetic diamond as metallic inclusions or as tiny particles. Similar results have been obtained by this analytical method for other synthetic diamonds (particularly those that contain visible metal inclusions; see, e.g., Shigley et al., 1993b). Although iron has been found in natural diamonds (as an iron sulfide or oxide mineral), and as such may not be helpful for identification purposes, the presence of nickel in a diamond is considered proof of laboratory growth.

Orange-Yellow. The following sharp (s) or broad (b) emission peaks were noted in one or more of the six orange-yellow samples on which PL spectra were taken: 543 (s), 566 (s), 573 (b), 581 (s), 614 (b), 637 (s), 672 (b), 701 (s), and 747 (s) nm (see, e.g., figure 11). Many of these peaks are thought to be due to nickel-nitrogen, cobalt-nitrogen, or nitrogen-vacancy complexes in the diamond crystal structure (Collins and Stanley, 1985; Lawson and Kanda, 1993a,b; Lawson et al., 1996). Two of the seven samples analyzed by EDXRF displayed no X-ray emission peaks, while the remaining five samples exhibited peaks due to nickel, iron, and/or cobalt. Again, the presence of nickel or cobalt is considered proof that a diamond is synthetic.

Yellow-Orange. The following sharp or broad peaks were noted in one or more of the PL spectra for the five yellow-orange samples tested: 547 (s), 575 (s), 581 (s), 599 (s), 604 (s), 623 (s), 637 (s), 639 (s), 694 (s), 701 (s), 727 (s), 747 (s), 753 (s), 776 (s), 794 (s), and 805 (s) nm (again, see figure 11). Of the six samples analyzed by EDXRF, the spectra of three displayed no X-ray emission peaks, while the spectra of the other three exhibited peaks due to nickel, iron, or cobalt.

Figure 11. The photoluminescence spectra of all the Gemesis synthetic diamonds tested exhibit the sharp 1332.5 cm^{-1} Raman peak that is characteristic of diamond, as well as several PL peaks. The peak at 566 in the orange-yellow sample (top) is due to the presence of cobalt, and is evidence of its synthetic origin. The PL spectrum of the yellow-orange synthetic diamond (bottom) displays a different set of peaks, with the ones at 727, 747, and 753 nm (due to nickel) providing evidence of synthetic origin.

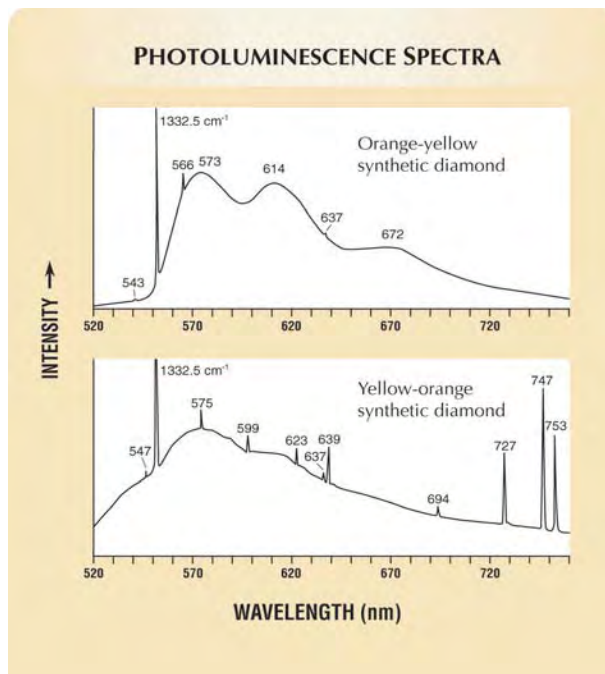



Figure 12. This 1.76 ct yellow Gemesis laboratory-grown diamond, set in a ring with colorless natural diamonds (1.10 ct total weight), is one example of the use of this material in fine jewelry. Photo by Elizabeth Schrader.

MEANS OF IDENTIFICATION

Shigley et al. (1995) summarized the gemological methods of distinguishing natural and synthetic diamonds. On the basis of their examination of yellow synthetic diamonds from Russia, Shigley et al. (1993b), Scarratt et al. (1994), and Sosso (1995) identified their diagnostic features as a cuboctahedral crystal shape and striated or dendritic crystal surface features; crystallographically oriented color zoning; planar or angular graining (along growth-sector boundaries); patterns of yellow or greenish yellow luminescence of varying intensity that correspond to the patterns of color zoning; and opaque metallic, small black triangular, or tiny pinpoint inclusions. Additional distinguishing features can be obtained by visible, infrared, and PL spectroscopy; by fluorescence imaging techniques such as cathodoluminescence and the De Beers DiamondView; and by chemical analysis to detect nickel or cobalt.

In comparison to synthetic diamonds that GIA researchers or others examined previously, the Gemesis material exhibits fewer distinctive visual gemological features. Their yellow/colorless zoning, metallic inclusions, and weak cross-shaped fluorescence patterns are all diagnostic of synthetic diamonds. In addition, their color is more saturated than that of most natural type Ia yellow diamonds (although it can resemble that of natural and other synthetic type Ib diamonds). The cathodoluminescence and De Beers DiamondView luminescence images of the Gemesis samples are unique to synthetic diamonds. Although the visible and infrared spectra were not useful for identification purposes,

photoluminescence spectra revealed weak spectral emission peaks due to nickel or cobalt that are indicative of synthetic origin. The laboratory-grown character of this material could be detected by the presence of nickel or cobalt in the EDXRF spectra. However, the absence of these trace elements does not necessarily mean that a particular sample is natural, since two yellow, two orange-yellow, and three yellow-orange specimens lacked these indicators.

EXPERIMENTAL SYNTHETIC DIAMONDS

Gemesis scientists have also grown other kinds of synthetic diamonds on an experimental basis, although the company has not finalized plans to produce them commercially at this time. In addition to the group of 30 commercial samples we examined, we also documented the following experimental specimens:

1. A colorless type IIa 0.20 ct round brilliant, which did not exhibit any X-ray emission peaks in its EDXRF spectrum, and had only a weak fluorescence to short-wave UV radiation, but did display persistent greenish blue phosphorescence (lasting more than 1 minute) after exposure to short-wave UV. This phosphorescence is a key identifying feature of colorless synthetic diamonds.
2. A bluish green irradiated type IIa 0.42 ct round brilliant, which exhibited an X-ray emission peak due to iron and a GR1 radiation band at 741 nm in its absorption spectrum.
3. A blue type IIb 0.55 ct crystal, which exhibited X-ray emission peaks due to iron and cobalt.
4. A green irradiated type IaA 0.65 ct rectangular cut, and a yellow-green type IaA 0.42 ct square cut, both of which displayed facet-related color zoning typical of treated colored diamonds that have been irradiated with electrons or other charged particles. The 0.65 ct sample also exhibited an X-ray emission peak due to iron.

CONCLUSIONS

High-quality yellow laboratory-grown diamonds produced by the Gemesis Corp. represent one of the first commercially available sources of this material specifically for use in the gem and jewelry trade. The company is focusing its marketing approach on the sale of rough and polished stones to jewelry

manufacturers (figure 12) and retailers. There are no current plans for the company to produce finished jewelry.

Gemesis is making every effort to prevent the misrepresentation of their laboratory-grown diamonds, and is cooperating with the jewelry industry to provide appropriate identification markings, laboratory certification reports, and factual promotional material. These steps are important since there is no inexpensive testing meter available to quickly

distinguish all natural from synthetic yellow diamonds. The best gemological clues to detecting Gemesis laboratory-created yellow diamonds are color zoning and/or metallic inclusions (as seen with a gemological microscope), and their patterns of UV fluorescence. Since these visual indicators may be absent, confirmation of the identity of a Gemesis synthetic diamond may require testing at a gemological laboratory with the appropriate advanced instrumentation.

ABOUT THE AUTHORS

Dr. Shigley (jshigley@gia.edu) is director of GIA Research in Carlsbad, California. Dr. Abbaschian (rabba@mse.ufl.edu) is professor of Materials Science and Engineering at the University of Florida in Gainesville, and Mr. Clarke (cclarke@gemesis.com) is co-chairman of the Gemesis Corporation in Sarasota, Florida.

ACKNOWLEDGMENTS

The authors thank the following GIA and GIA Gem Trade Laboratory staff in Carlsbad and New York for their assistance in documenting the study samples: Shane Elen, Scott Guhin, Matthew Hall, Shane McClure, Sam Muhmeister, and Dr. Wuyi Wang. Both Simon Atlas of New York City and Less Wright of Bellevue, Washington, provided polished Gemesis samples for study.

REFERENCES

- Attrino T. (1999) U.S. scientists, Russians produce new synthetic diamonds. *Rapaport Diamond Report*, Vol. 22, No. 36, pp. 88–89.
- Collins A.T., Stanley M. (1985) Absorption and luminescence studies of synthetic diamond in which the nitrogen has been aggregated. *Journal of Physics D: Applied Physics*, Vol. 18, No. 12, pp. 2537–2545.
- Crowningshield R. (1971) General Electric's cuttable synthetic diamonds. *Gems & Gemology*, Vol. 13, No. 10, pp. 302–314.
- Koivula J.L., Fryer C.W. (1984) Identifying gem-quality synthetic diamonds: An update. *Gems & Gemology*, Vol. 20, No. 3, pp. 146–158.
- Lawson S.C., Kanda H. (1993a) An annealing study of nickel point defects in high-pressure synthetic diamond. *Journal of Applied Physics*, Vol. 73, No. 8, pp. 3967–3973.
- (1993b) Nickel in diamond: An annealing study. *Diamond and Related Materials*, Vol. 2, Nos. 2–4, pp. 130–135.
- Lawson S.C., Kanda H., Watanabe K., Kiflawi I., Sato Y., Collins A.T. (1996) Spectroscopic study of cobalt-related optical centers in synthetic diamond. *Journal of Applied Physics*, Vol. 79, No. 8, pp. 4348–4357.
- Lerner E.J. (2002) Industrial diamonds gather strength. *Industrial Physicist*, Vol. 8, No. 4, pp. 8–11.
- Palyanov Y.N., Malinovsky Y., Borzdov Y.M., Khokhryakov A.F. (1990) Use of the "split sphere" apparatus for growing large diamond crystals without the use of a hydraulic press. *Doklady Akademii Nauk SSSR*, Vol. 315, No. 5, pp. 233–237.
- Palyanov Y.N., Khokhryakov A.F., Borzdov Y.M., Sokol A.G., Gusev V.A., Rylov G.M., Sobolev N.V. (1997) Growth conditions and real structure of synthetic diamond crystals. *Russian Geology and Geophysics*, Vol. 38, No. 5, pp. 920–945.
- Palyanov Y.N., Borzdov Y.M., Sokol A.G., Khokhryakov A.F., Gusev V.A., Rylov G.M., Sobolev N.V. (1998) High-pressure synthesis of high-quality diamond single crystals. *Diamond and Related Materials*, Vol. 7, No. 6, pp. 916–918.
- Scarratt K., Du Toit G., Sersen W. (1994) Russian synthetics examined. *Diamond International*, No. 28, pp. 45–52.
- Shigley J.E., Fritsch E., Kammerling R.C., Koivula J.L., Moses T.M. (1993a) Identifying gem-quality synthetic diamonds. *Rapaport Diamond Report*, Vol. 16, No. 26, pp. 10–13.
- Shigley J.E., Fritsch E., Koivula J.L., Sobolev N.V., Malinovsky I.Y., Palyanov Y. (1993b) The gemological properties of Russian gem-quality synthetic diamonds. *Gems & Gemology*, Vol. 29, No. 4, pp. 228–248.
- Shigley J.E., Fritsch E., Reinitz I., Moses T.M. (1995) A chart for the separation of natural and synthetic diamonds. *Gems & Gemology*, Vol. 31, No. 4, pp. 256–264.
- Sosso F. (1995) Some observations on a gem-quality synthetic yellow diamond produced in the region of Vladimir (Russia). *Journal of Gemmology*, Vol. 24, No. 5, pp. 363–368.
- Strong H.M., Chrenko R.M. (1971) Further studies on diamond growth rate and physical properties of laboratory-made diamonds. *Journal of Physical Chemistry*, Vol. 75, No. 12, pp. 1838–1843.
- Strong H.M., Wentorf R.H. (1971) The growth of large diamond crystals. *Die Naturwissenschaften*, Vol. 59, No. 1, pp. 1–7.
- (1991) Growth of large, high-quality diamond crystals at General Electric. *American Journal of Physics*, Vol. 59, No. 11, pp. 1005–1008.
- Welbourn C.M., Cooper M., Spear P.M. (1996) De Beers natural versus synthetic diamond verification instruments. *Gems & Gemology*, Vol. 32, No. 3, pp. 156–169.
- Wentorf R.H. (1971) Some studies of diamond growth rates. *Journal of Physical Chemistry*, Vol. 75, No. 12, pp. 1833–1837.
- Wilks E., Wilks J. (1994) *Properties and Applications of Diamond*. Butterworth-Heinemann, London, 525 pp.

LEGAL PROTECTION FOR PROPRIETARY DIAMOND CUTS

By Thomas W. Overton

Despite the rapid profusion of new branded and proprietary diamond cuts in recent years, considerable confusion exists in the trade about the important differences between trademarks and patents. Proprietary brand names can be protected by trademark registration (typically noted by a registration [®] symbol next to the brand name), while proprietary designs or products can be protected by patents. Both methods have important limitations, and the recent history of cut designs reflects the importance of protecting a valuable diamond cut. A study of the proprietary designs currently in the marketplace revealed a preference for trademark protection over patents, though many designs appeared to have no patent or trademark registration. A list of recent proprietary designs is given in the Appendix.

The past few decades have seen a rapid expansion in the number of proprietary diamond cuts available on the market (Drucker, 2000; Misiorowski, 2000; see figure 1). Much of this expansion has come in the last few years, concurrent with radical changes in the diamond pipeline, widespread reliance on standardized price lists, advances in diamond cutting technology (see Caspi, 1997), and falling profit margins throughout the industry. The challenges—and opportunities—of this changing market have led diamond manufacturers to seek new ways to distinguish their polished products and add recoverable value to their inventory (Scriven, 1997; Shor, 2001; Even-Zohar, 2002). Although new cut designs are frequent subjects of press releases and short news items in industry publications (see, e.g., Johnson and Koivula, 2000; Moses and Reinitz, 2002; “Who’s who . . .,” 2002), little attention has been paid to the legal methods required to protect these valuable designs. This article attempts to bridge this gap by first looking at the legal protections available in the United States and internationally, and then examining the legal status of many of the proprietary cut designs currently in the marketplace.

LEGAL PROTECTION FOR DIAMOND CUT DESIGN IN THE UNITED STATES

At the outset, any treatment of the subject must recognize that “branding” tends to mean different things to different people (see Even-Zohar, 2002). Thus, a distinction needs to be made between protecting a diamond cut design and merely protecting the brand name for it. Unfortunately, whether in spite of, or because of, the recent proliferation of new designs, considerable confusion exists in the diamond trade about the differences between patents and trademarks (registered and unregistered)—assuming the subject receives any attention at all. At GIA’s Third International Gemological Symposium in 1999, panel discussions addressed both Diamond Cut and Branding; yet the reports of these discussions made no mention of the issue of intellectual property protection (Even-Zohar, 1999; Sielaff, 1999). The trade press often complicates matters by using

See end of article for About the Authors and Acknowledgments.
GEMS & GEMOLOGY, Vol. 38, No. 4, pp. 310–325.
© 2002 Gemological Institute of America

Figure 1. New proprietary diamond cut designs such as these have become increasingly popular in recent years. Shown from left to right are a 1.74 ct Lucère® cut, a 3.23 ct Royal Asscher® cut, a 0.51 ct Asprey® cut, a 2.12 ct Eternal® cut, and a 0.94 ct radiant cut. The Eternal and Royal Asscher cuts are patented designs; the radiant design was once patented, but the patent has expired. Photo by Maha Tannous.



the terms *patent* and *trademark* incorrectly or interchangeably. One article on diamond branding, for example, asserts that “Trademarking . . . involves patenting of an idea” (Scriven, 1997), which is incorrect on at least three different levels (one can neither patent nor trademark a mere idea).

Confusion in this area is understandable, given the fact that “intellectual property” is actually a legal fiction; that is, it is “property” that exists only because rights to certain forms of human expression have evolved from centuries of case history or have been specifically created by statute. As such, they differ fundamentally from traditional property rights derived from possession of a piece of land or a physical object. Very generally, “intellectual property” means a set of rights, derived from statute and/or case law, that delineate the usage and ownership of specific, well-defined expression created by human intellect. Patents and trademarks are both forms of intellectual property.

For a diamond manufacturer seeking to protect a new cut design, as well as for a jeweler or gemologist seeking to make sense of the plethora of new products on the market, the distinctions between trademark and patent are important and should not be glossed over, as their respective intent, scope, duration, and durability differ in many significant ways. This discussion focuses initially on United States law; international law is addressed in the next section.

Trademarks. A trademark is a word, phrase, logo, or other graphic design intended to identify the source of a product or service in a specific industry. The

origins of the basic concept are lost in antiquity, but the idea of a formal government registration scheme did not evolve until the 19th century. Federal trademark registration in the U.S. was first established by the Trade-Mark Act of 1881. The Act has been revised repeatedly since then, and trademark registration in the U.S. is currently governed by Title 15, Sections 1051–1129, of the United States Code (information in this section is drawn from there unless otherwise noted).

In the U.S., trademarks *may* be registered with the U.S. Patent and Trademark Office (USPTO), but need not be. Continued and consistent use is enough to establish a mark in the marketplace. *Gems & Gemology*, for example, has been the name used by GIA to identify this journal since 1934, but it has only been a *registered* trademark since 1999.

Unregistered, or “common law,” marks can display a trademark symbol (™) but not a registration symbol (®). (See Title 15, Section 1111; note, however, that certain state and local laws may govern the use of the ™ symbol as well.) Ownership of a mark is *not* dependent on registration; rather, it depends on the use of the mark in commerce. However, registration conveys a number of important benefits, among them a legal presumption of ownership, distinctiveness, and trade usage that any opposing party would have to overcome with competent evidence should the trademark owner ever need to sue for unauthorized usage or other infringement of the mark.

The assistance of an attorney is not required to secure a federal trademark registration, though it can help. Registrations are reviewed by the USPTO to determine if the mark is too descriptive or generic,

or if it conflicts with existing registered marks. However, identical or nearly identical trademarks can be employed for different purposes if there is no likelihood of confusion. Although the minutiae of the classification system are beyond the scope of this article, trademarks are grouped into different classes depending on their intended use (see Code of Federal Regulations Title 37, Section 6.1, for full definitions of the current classes). For example, the term CrissCut is a registered trademark (class 14; the class for most sorts of jewelry and related items) for the patented diamond design created by Christopher Slowinski (Slowinski, 1997). The same term, however, has also been trademarked (class 29) by Lamb-Weston Inc., for a particular type of French-fried potatoes (Lamb-Weston, 2002). Because there is little danger of confusing the two usages, CrissCut fries and CrissCut diamonds can both exist in the same economy without creating trademark problems. (If you want to determine if someone else has registered a trademark you want to use, you can search for it with the USPTO's Trademark Electronic Search Service [<http://tess.uspto.gov>].)

Both common law marks and registered marks have important limitations. The rights to both types may be lost or considered abandoned if they are not used or if they are not defended when infringed. The owner of a registered mark also must file periodic affidavits of continued use with the USPTO (on the fifth anniversary after registration and on every subsequent 10-year anniversary thereafter) or the registration will be cancelled.

Further information about registering a trademark can be obtained from the USPTO Web site (<http://www.uspto.gov/web/offices/tac/doc/basic>).

Patents. A patent is the grant of a right to prevent others from making, using, selling, or importing an invention for a set period of time, which varies depending on the type of patent (information in this section is drawn from Title 35, Sections 100–376, of the United States Code unless otherwise noted). Unlike trademarks, which existed (and still exist) at common law, patents are solely a creation of statute. They exist only when they are issued by the USPTO.

A patent may be obtained for any “new and useful process, machine, manufacture, or composition of matter, or any new and useful improvement thereof . . .” (Title 35, Section 101). The invention need not be a physical object; in fact, the very first U.S. patent, issued in 1790, was for a method of making potash, a common component of agricul-

tural fertilizers (Hopkins, 1790). However, the invention *must* be new (i.e., not something previously invented), “non-obvious” (meaning a genuine innovation), useful, and original to the inventor making the application (Title 35, Sections 101–103).

Patent prosecution (the legal term for securing a patent) can be an arduous process. The services of an experienced patent attorney are usually required, as poorly prepared applications can significantly limit the scope of a patent (if they are not rejected outright). The application must pass a review by USPTO examiners, and multiple revisions are typically necessary before the patent issues. The delay between filing and issue is normally several years, and can extend a decade or longer if competing inventors contest the application. An invention can be referred to as “patent pending” during the period between filing and issue. For utility patents (discussed below), protection is retroactive to the date of filing if the patent ultimately is issued.

A patent is a form of property, which means that it can be sold, licensed, given away, or abandoned like any other sort of personal property. It is important to understand, however, that patent rights are *exclusionary*; that is, they are rights to exclude others from making use of an invention. Whether the *inventor* may manufacture or market a particular invention is another matter entirely, one that is subject to other existing laws.

Patents are time-dependent. Any use, sale, or publication of the invention (by anyone, not just the inventor) more than one year prior to application generally will prevent the issue of a patent. If an inventor intends to patent his invention, the application should be made before any disclosure or commercial use is made of it. (It is possible to gain an additional one-year grace period by filing what is known as a “provisional” application, but this is a process fraught with some pitfalls. The complexities of provisional applications—which are many and varied—are matters to be discussed with one’s attorney.)

Unlike a trademark, a patented invention need not be sold, manufactured, or used in any way for the patent to persist. Thus, “protective patents,” in which someone patents a device or process simply to prevent competitors from using it—without any intention of using it him or herself—are permitted. De Beers, for example, has employed protective patents in an attempt to prevent the use of certain treatment and synthesis processes (De Beers Industrial Diamonds et al., 2001a–c; Schmetzer, 2002).

There are two main types of patents, utility and design, each with somewhat different protections (there is also a third type, not relevant here, for plants).

Utility Patents. A utility patent protects the construction of an invention, how it works, or how it is used. As such, the application must provide a carefully detailed and specific description of the nature of the invention and what it does if protection is to be adequate. For diamond cut designs, this means providing precise geometric descriptions of the facet arrangements. As an illustration of just how much detail is required, here is the first sentence of the 13-page utility patent for Tiffany's Lucida cut (Greeff, 2002a):

A cut cornered mixed cut gemstone, comprising a girdle, a crown above said girdle and a pavilion below said girdle, said crown comprising a width and length formed by two pairs of opposing crown sides and four crown corners, each crown side and corner having a length along the girdle, said corner length being substantially less than said side length, said crown also comprising at least two steps, including a first step from the girdle to a crown break, and a second step from the crown break to a table break, said crown break defined by lines parallel with said girdle, said crown also having a substantially flat table, said table having one facet having four sides and four corners defined by lines parallel with said girdle, said pavilion having a bottom and comprising a substantially centrally located culet at the bottom of the pavilion, said pavilion also comprising two pairs of opposing pavilion sides and four pavilion corners defined by eight rib lines extending from the girdle to the culet, wherein each rib line extends in a substantially straight line when viewed from the bottom of the pavilion.

Obviously, such a description can only be prepared by an experienced cutter working in partnership with a qualified patent lawyer.

A utility patent application—and its contents—are confidential for the first 18 months after filing. The inventor may publicize the design before these 18 months are up (though there are few reasons for doing so), but the USPTO will not release any information about it. After 18 months, the USPTO publishes the application for public comment unless the inventor certifies that he or she will not seek to patent the invention outside the U.S. All this means that the details of the invention become public knowledge well *before* the patent is actually issued.



US 20020162356A1

(19) **United States**
 (12) **Patent Application Publication** (10) **Pub. No.: US 2002/0162356 A1**
 Wueste (43) **Pub. Date: Nov. 7, 2002**

(54) **BRILLIANT-CUT DIAMOND AND METHOD OF FORMING THEREOF** Publication Classification

(75) Inventor: **Robert J. Wueste**, Oceanside, CA (US) (51) Int. Cl.⁷ B28D 5/00; A44C 17/00
(52) U.S. Cl. 63/32; 125/30.01

Correspondence Address:
Edward M. Weisz, Esq.
Cohen, Pontani, Lieberman & Pavane
 Suite 1210
 551 Fifth Avenue
 New York, NY 10176 (US) (57) **ABSTRACT**

(73) Assignee: **Samuel Aaron, Inc.**
 (21) Appl. No.: **10/083,279**
 (22) Filed: **Feb. 25, 2002**

Related U.S. Application Data

(60) Provisional application No. 60/271,241, filed on Feb. 23, 2001.

A brilliant-cut gemstone having a pavilion, girdle, and crown is disclosed. The pavilion of the gemstone has 56 facets: specifically, 8 lower diamond-shaped facets, 16 middle kite-shaped facets, and 32 upper triangular facets. The girdle and table may be formed of one or more facets. In one preferred embodiment, the total number of crown facets (excluding the table) is 56, making a total of 114 facets (including the table). In another preferred embodiment, the total number of crown facets (excluding the table) is 64, making a total of 122 facets (including the table).

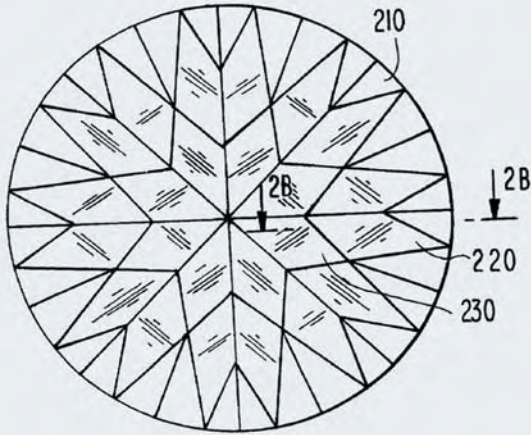

Figure 2. This is the first page of the published patent application for a 122-facet proprietary diamond design created by Robert J. Wueste (“Inventor”) of Oceanside, California. As “Assignee,” Samuel Aaron Inc. of New York has been assigned rights to the design, should the patent be granted. This application is a follow-up to a “provisional” application, which is discussed in the text. “Publication Classification” lists the patent classes, also discussed in the text. The numbers in parentheses refer to internal USPTO codes for each category of information.

Published applications can be obtained from the USPTO (the easiest method is through the USPTO Patent Full-Text and Full-Page Image Databases at <http://www.uspto.gov/patft>). A portion of a published application for a diamond cut patent is shown in figure 2.

While the information in a published patent application is not protected (yet), and nothing stops a competitor from using it to his or her advantage, caution is still advised. Should the patent issue, pro-

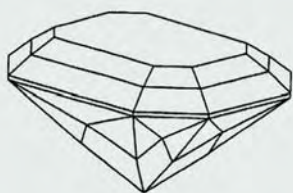

Figure 5

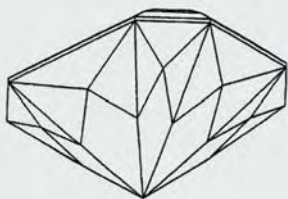

Figure 6

Figure 3. This portion of the design patent application for Tiffany's Lucida® cut shows a precise diagram of the design.

tection is retroactive to the date of filing, and the patent holder can then collect a fee from any party that has made use of the invention. These amounts can be substantial in cases where there are long delays between filing and issue (K. Schmetzer, pers. comm., 2002). In general, a patent ought to be issued (or denied) within three years of application. Should the USPTO's decision take longer than three years, the term of the patent will be extended for as long as the delay lasts, provided that the inventor has been reasonably diligent in prosecuting the application.

For utility patents applied for after June 8, 1995, protection extends for 20 years from the date the application was filed. For earlier patents, the term is either 20 years from filing or 17 years from the date of issue, whichever is greater.

Design Patents. A design patent protects any "new, original and ornamental design for an article of manufacture," for a period of 14 years from the date of issue (Title 35, Section 171). A design patent protects *only* the ornamental appearance of the invention and not any of its functional, structural, or utilitarian elements. Design patent applications tend to be fairly simple, as all that is necessary is a comprehensive graphic depiction of the design; detailed descriptions are not required. A portion of the design patent for Tiffany's Lucida cut is shown in figure 3 (Greff, 2002b). In general, it is easier to obtain a design patent than a utility patent, and design patent applications are not published as utility patents are (though the patent itself is, once issued).

Note that, as Tiffany has done for the Lucida cut, it is entirely permissible to apply for and receive two different patents—one for design and one for function—for what is essentially one invention, as long as the design and function are not easily separable.

Modern diamond cut patents often exist in tandem: a design patent for the appearance of the finished diamond, and a utility patent for the way it transmits light and creates brilliance.

The interrelationship between patent and trademark is important. One may register trademarks for designs that cannot be patented, and one may secure a patent for one's design only to see its trademark protection lost (e.g., from failure to defend the name or failure to file the required affidavits) after it is already on the market. The existence of one is no guarantee of obtaining—or retaining—the other.

Like trademarks, patents have classifications. Gemstone design patents are classified as D11/89 and/or D11/90; gemstone utility patents as 63/32 (knowing these classes makes searching for patents in the USPTO database much easier).

Table 1 summarizes some of the more important distinctions between trademarks and the two types of patents for a diamond cut design. Further information on U.S. patent applications can be obtained from the USPTO (<http://www.uspto.gov/web/patents/howtopat.htm>).

Other Potential Means of Protection. "Intellectual property" encompasses not just patent and trademark but also copyright, trade dress, and trade secret. While there have been historical attempts to

TABLE 1. Distinctions between trademarks, utility patents, and design patents for a diamond cut design.^a

Trademark	Utility patent	Design patent
Protects brand name of cut	Protects how cut transmits light and creates brilliance, fire, and scintillation	Protects ornamental appearance of cut
Same name can be used in different industries	Exclusive to patent holder	Exclusive to patent holder
Name need not be registered if used in commerce	Patent must be filed for and issued by USPTO	Patent must be filed for and issued by USPTO
Name can be registered long after first use	Patent application must be filed within one year of first use or public disclosure of cut design	Patent application must be filed within one year of first use or public disclosure of cut design
Name must be used in commerce after registration	Design need not be used, sold, or manufactured	Design need not be used, sold, or manufactured
Duration indefinite if affidavits of continued use are timely filed	20 year duration from date of filing (or 17 years from issue for patents applied for prior to June 8, 1995, if this is longer)	14 year duration from date of issue
Class 14	Class 63/32	Classes D11/89 and/or D11/90

^aSources: Code of Federal Regulations Title 37; U.S. Code Titles 15 and 35.

use these other methods to protect diamond and jewelry designs, in general they have not been very effective (R. Shor, pers. comm., 2002). Copyright protects “original works of authorship” including “sculptural works” (Title 17, Section 102). While one can argue that a diamond cut is a “sculptural work,” a certain minimum amount of creative expression is required. Without going into too much detail, the U.S. federal courts have required more original artistic expression than exists in a diamond cut design, though not in a piece of jewelry (see Hazard, 2001, pp. 2-7 to 2-10, for a general discussion of this issue).

Trade dress is a form of unfair competition law. It protects the total, overall impression created by a product or its packaging, that is, the size, shape, color, texture, or graphics—at the most basic level, the “look” and image of a product or its packaging in the consumer’s mind (Jassin and Schechter, 2000). Trade dress can be registered with the USPTO as trademarks are, as long as it is nonfunctional and the product has acquired a secondary meaning. A line of jewelry and its packaging, such as Tiffany’s famous blue box, might constitute protectable trade dress, though there are examples, such as designer David Yurman’s attempts to protect his cable-themed designs, where the courts have rejected such claims (Donahue, 2001; Kekahbah, 2000). A diamond cut alone, however, does not qualify as trade dress.

Trade secret is, straightforwardly enough, the means by which one protects internal, proprietary trade knowledge. If the creation of a proprietary diamond design requires an original, specialized manufacturing process, that process could be considered a trade secret. The process must, however, remain secret. If it can be readily ascertained through legal means by persons who can obtain economic value from it, it is not protectable as a trade secret (see Uniform Trade Secrets Act, Section 1[4]). A diamond cut design, given that its facet arrangement is obvious to any trained observer, would not qualify as a trade secret.

INTERNATIONAL PROTECTION OF DIAMOND CUT DESIGN

The discussion thus far has focused on United States law, but in an industry as global as the diamond trade, manufacturers must also be aware of laws in other countries. A full discussion of the complexities of international patent and trademark

conventions is beyond the scope of this article, but some important elements can be noted.

There is currently no single “international” patent or trademark registration that would be valid throughout the world. One must still secure protection in each country where it is desired, but an increasing number of methods are available to simplify this process. An international, non-governmental agency known as the World Intellectual Property Organization (WIPO), headquartered in Geneva, administers a body of treaties designed to harmonize international treatment and protection of intellectual property. About 90% of the world’s countries are members of WIPO (a full list can be found at <http://www.wipo.int/members/members>). This harmonizing process is a dynamic and ongoing one, and the ultimate goal of uniform treatment for patents and trademarks is still some distance off (WIPO, 2001). However, the so-called Madrid Protocol on the international registration of trademarks and the Patent Cooperation Treaty (PCT), both of which are discussed below, offer some hope for a more organized future.

Trademarks. As noted above, trademark protection typically ends at a country’s borders, and a U.S. trademark owner must file individual registrations in all countries where protection is desired (except within the European Union [EU], as discussed below). Not all countries have trademark registration schemes but, in general, filing for registration in a WIPO member country will relate back to the U.S. filing date provided it occurs within six months of the U.S. filing (Paris Convention, 1979). With some luck, this frustrating situation may soon be seeing its last days.

The Madrid Protocol is the latest installment in a process that began in 1891; it attempts to set up a unified international system for registration of trademarks (Prah, 2002; WIPO, 2002b). WIPO has been working hard to advance worldwide acceptance of this protocol, but thus far only 56 countries are members. The U.S. is a notable non-member, though, as of late 2002, ratification was pending before the U.S. Senate (and is expected by most observers). The Madrid Protocol does have some important differences from U.S. law; among them are the absence of a requirement of initial use and a narrower definition of what constitutes similarity for conflicting trademarks. Further information can be obtained from the WIPO (<http://www.wipo.int/madrid/en>).

Nearly all of the European nations are party to

DESIGN.

J. G. C. COTTIER.
PRECIOUS OR IMITATION STONE.

No. 20,043.

Patented July 22, 1890

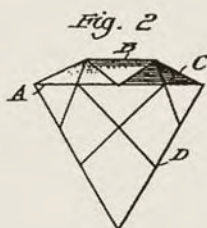

WITNESSES:
J. H. Clark.
C. Sedgwick

INVENTOR:
J. G. Cottier
BY *Munn & Co.*
ATTORNEYS

Figure 4. The earliest U.S. patent for a gemstone cut is this 1890 design by J. G. C. Cottier.

the Madrid Protocol, but registration throughout the EU can also be accomplished by a single trademark filing known as a Community Trademark (CTM). The CTM is a specially designed registration that exists separately from individual country trademarks, and it creates rights that cover all 15 EU nations. Further information on the CTM can be obtained from the Office for Harmonization in the Internal Market (Trademarks and Designs), known as OHIM, at <http://oami.eu.int/en>.

Utility Patents. A diamond manufacturer cannot, yet, secure a utility patent through the WIPO, but it is possible to *begin* the application process in multiple countries by filing a Patent Cooperation Treaty (PCT) application with the USPTO, a foreign patent office, or the WIPO (WIPO, 2002a). Once the application is filed, the manufacturer has up to 30 months to proceed with local patent prosecution in the countries selected on the application. This is a significant benefit because, among other reasons, a critical difference exists between U.S. and Japanese and European patent law. In the United States, patents are issued to the first inventor. If two inventors claim the same invention, the USPTO will examine the relevant evidence (notes, data, correspondence,

publications, etc.) to determine who first created the invention. In Japan and Europe, however, there exists what is often called “a race to the patent office”: Whoever files first will normally get the patent, regardless of the date of invention.

Like the Madrid Protocol, a PCT application can avoid a lot of problems with inventions intended for an international market (such as a diamond cut), but the process has its own unique procedures and requirements, some of which vary depending on the countries selected. Nearly all major world countries are PCT-participating states (Namibia, Botswana, and Thailand are important exceptions for the gem trade). Further information on PCT applications can be obtained from WIPO (<http://www.wipo.int/pct/en>), the USPTO (<http://www.uspto.gov/web/offices/pac/dapps/pct>), and the European Patent Office (http://www.european-patent-office.org/ap_gd/part_2/index_pdf_e.htm).

In addition to what is available through the PCT, most of Europe has had a uniform utility patent system under the auspices of the European Patent Office (EPO) since 1977 (Norway and Poland are the main exceptions). Like Community Trademarks, an EPO patent does not replace national patents; the same invention can have both an EPO patent and patents from, say, Germany and France.

Design Patents. First, it is important to realize that design patents tend to get different treatment—sometimes very different treatment—outside the United States than they do inside. Among other things, there is no international design patent scheme comparable to the PCT, though there are some regional processes.

In the EU, the protection scheme for industrial designs resembles U.S. copyright rules almost as much as it does U.S. patent rules (see Spencer, 2002). Under a regime adopted in 2002, even *unregistered* designs are automatically protected for a term of three years after the design is first made available to the public. Beginning in January 2003, registered designs are protected for five years, with protection renewable in five-year increments up to 25 years. While this is 11 years longer than the term of a U.S. design patent, the protection is not quite as strong. For example, a very important difference exists in what constitutes infringement: Unlike U.S. patent law (but similar to “fair use” provisions in U.S. copyright law; see Title 17, Section 107), a registered Community Design is not protected from private, noncommercial use or reasonable educational use.

As with CTMs and EPO patents, a Community

Design is a community-wide patent, and can co-exist with a national design patent. Further information can be obtained from the OHIM, which administers Community Designs in addition to Community Trademarks.

A BRIEF HISTORY OF PATENTED DIAMOND CUTS

The general evolution of modern diamond cuts is covered exhaustively in Bruton (1970) and Tillander (1995), among many other authorities, and need not be repeated here. Unfortunately, these references, while otherwise authoritative, typically pay little or no attention to the issue of intellectual property protection.

The very first U.S. patent for a gemstone design was issued to J. G. C. Cottier of New York City on July 22, 1890, for a rather odd triangular cut (figure 4). One must wonder at the sort of jewelry setting for which this design might have been intended.

The next few years would see the issuance of a small flurry of patents. The year 1902 saw three patents, the first to David C. Townsend, also of New York City (figure 5, top), and the second and third to Ernest Schenck, a Belgian cutter living in New Jersey (figure 5, bottom), for cuts that bear a strong resemblance to the Jubilee cut (figure 5, inset), named in honor of the 60th anniversary of British Queen Victoria's coronation in 1897, her Diamond Jubilee (Schenck, 1902a,b; Townsend, 1902; Tillander, 1995). History does not record the motivations behind Townsend's or Schenck's respective designs, but there are likely some parallels between these two cuts and the recent proliferation of designs for modified round brilliants.

Perhaps the first diamond manufacturer to conceive the idea of associating a diamond cut with a specific manufacturer was master cutter Joseph Asscher, who was well known around the turn of the 20th century for having cut the Cullinan diamond, the largest rough diamond in history (Bruton, 1970). Asscher secured a patent for his step-cut square, which became known as the Asscher cut, in 1902. The Asscher cut was recently updated by the Royal Asscher Co. of Amsterdam. The new cut has been patented and trademarked as the Royal Asscher cut (again, see figure 1).

Many other recent designs can likewise find antecedents in earlier patents. A 1903 cut patented by three members of the famous Tolkwowsky family is a strikingly modern hexagonal design (figure 6,

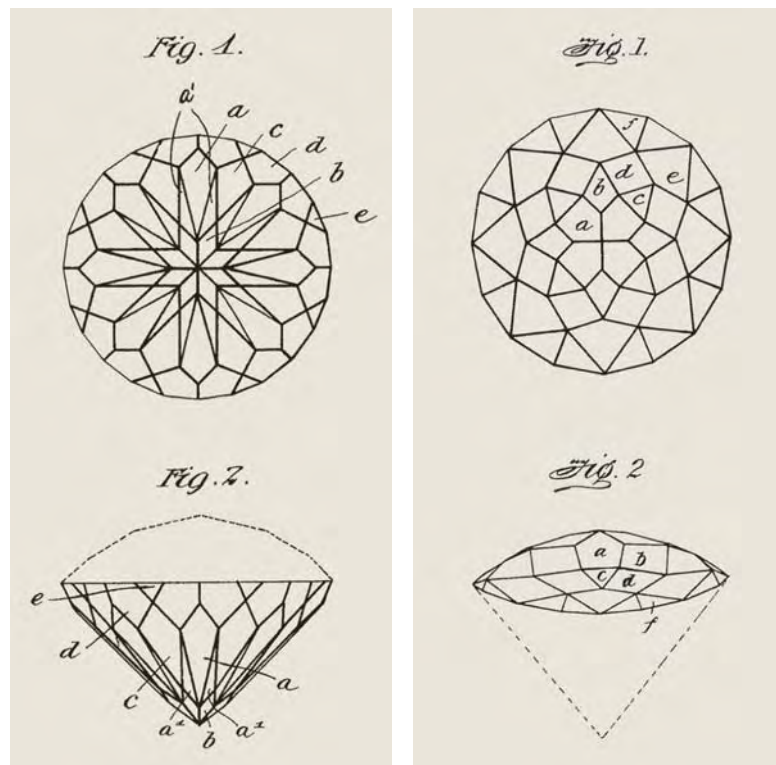
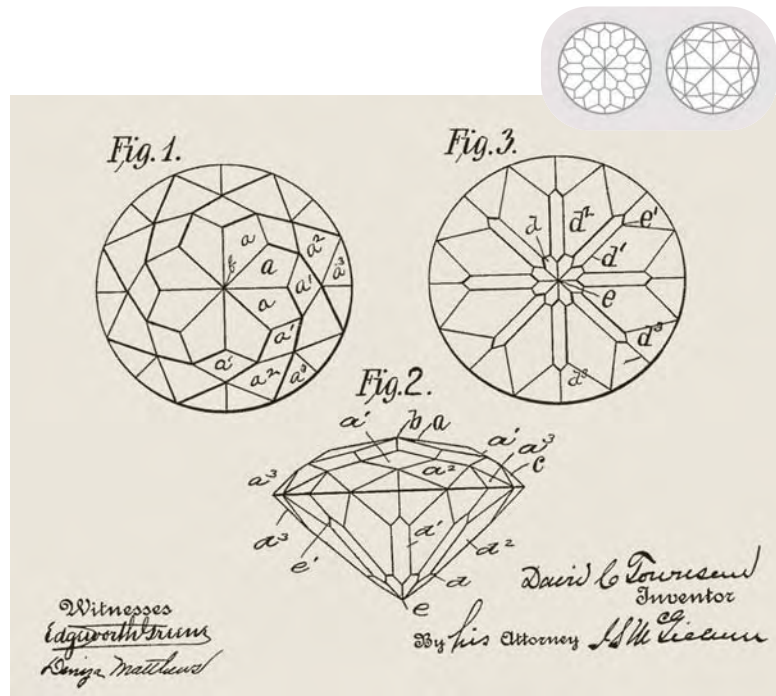

Figure 5. These three round designs by David C. Townsend (top) and Ernest Schenck (bottom, left and right) received patents in 1902 despite their similarities to the earlier Jubilee cut (inset), which was named for Queen Victoria's Diamond Jubilee in 1897.

left) that would be right at home alongside cuts created by their descendant Gabi (figure 6, top). A 1941 patent for a step-cut rectangle with a cross-shaped pavilion (figure 7, left), also issued to Ernest Schenck,

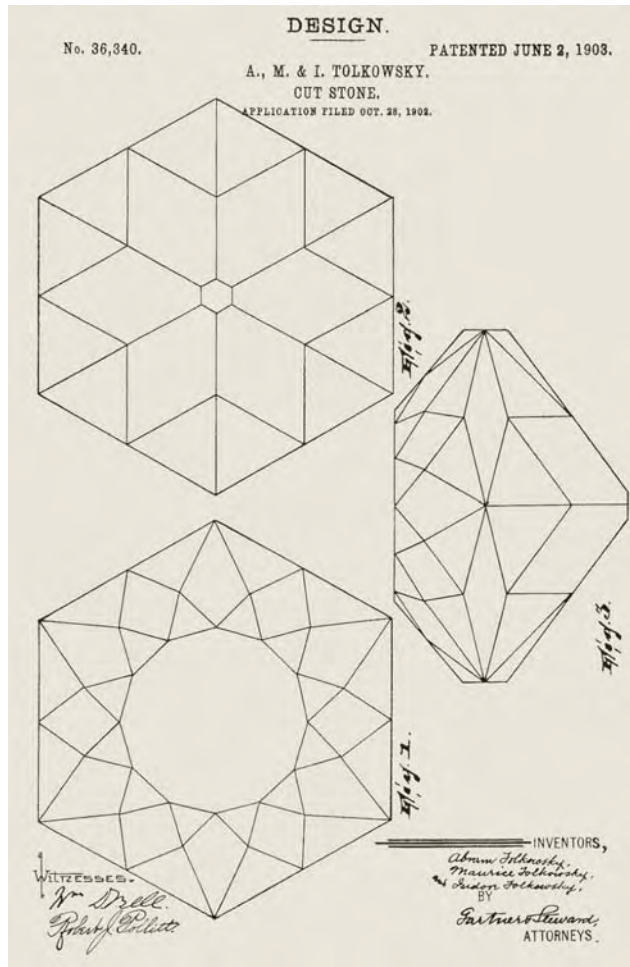

Figure 6. The FireRose cut (above), created by Gabi Tolkowsky for De Beers, strongly resembles a cut patented by members of the Tolkowsky family (left) almost a century earlier, in 1903. FireRose image © De Beers Group.

has elements that are similar to Basil Watermeyer's Barion cuts of the 1970s (figure 7, right; Schenck, 1941; Watermeyer, 1974).

Other cut elements that are now ubiquitous were once protected by patent. The polished girdle was the subject of yet another patent by Ernest Schenck in 1906 (figure 8), while the faceted girdle (see figure

9) was patented in 1944 by Edward Goldstein of Brookline, Massachusetts. All of these patents, lest the reader now be gripped by concerns of patent infringement, have long since expired.

Although these early patents are of some historical interest, for the most part they were aberrations. Of the approximately 300 U.S. patents (design and utility) ever issued for gem cut designs, all but a handful have been issued since 1975. Until that time, patenting a cut, even a highly successful one, was unusual. The source of this change in attitudes can be traced in the saga of the two most popular fancy cuts of the 1970s: Leon Finker's Trillion and Henry Grossbard's Radiant.

Figure 7. This 1941 design (left), also by Ernest Schenck, has some similarities to Basil Watermeyer's design for this Barion cut (right), which he patented in 1974.

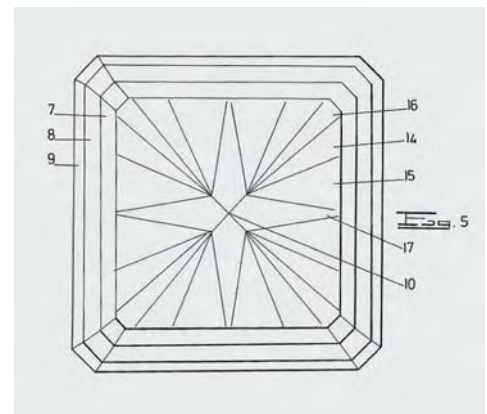
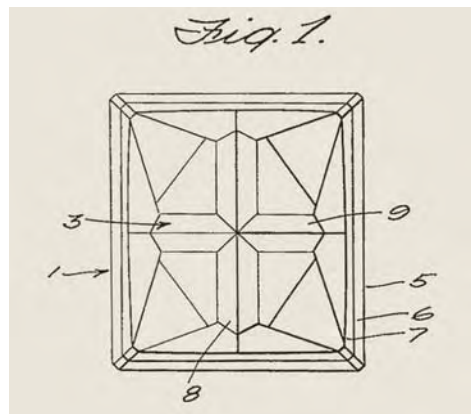

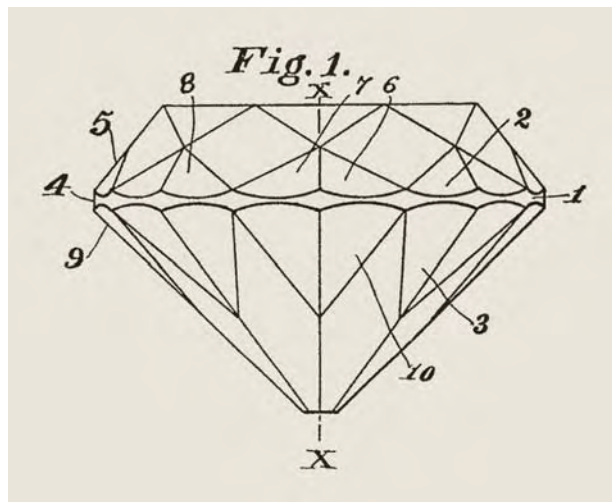

Figure 8. This drawing from Ernest Schenk's 1906 patent shows his design for a polished girdle.

Finker introduced his triangular brilliant design (figure 10, left) in the mid-1960s, but he (initially) neither tried to register the name nor apply for a patent, despite the popularity of his cut. About the same time, Grossbard began developing his innovative mixed cut (figure 10, right), but he, unlike Finker, patented his design and registered the brand name before putting it on the market (Grossbard, 1977).

Both manufacturers had profitable designs, but only Grossbard had complete control over his. By the time Finker—perhaps inspired by Grossbard—finally tried to protect his cut in the late 1970s, it had become so popular that consumers and jewelers alike were calling any triangular diamond a “trillion.” Finker got his patent (Finker and Finker, 1978), but he was unable to register the trademark. A federal judge in New York ultimately ruled that the word was too close to “trilliant,” which was then also in common usage (Geolat, 1991; Sielaff, 1991). Finker spent over a decade (and a great deal of money) trying to recapture the name through his advertising, but people throughout the trade continued using the term generically. In 1991, Finker finally conceded defeat (Sielaff, 1991). He registered a new name, “Trielle” (“Trillion Diamond Co. . . .,” 1991), but by this point his patent on the original trillion design had almost expired. Grossbard’s Radiant patent was soon to expire as well, but he had enjoyed almost two decades of a plum position in the market: having both patent and trademark protection for a highly popular design.

Henry Grossbard was certainly not the first per-

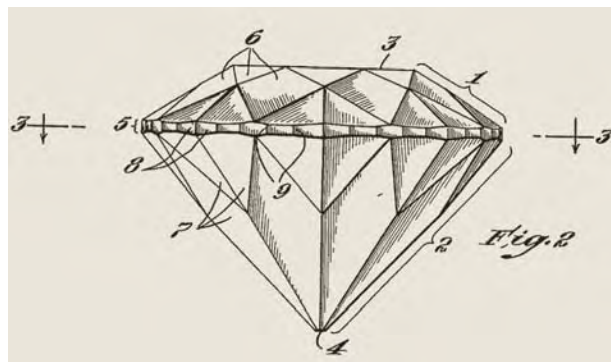

Figure 9. Edward Goldstein patented this design for a faceted girdle in 1946.

son to patent a notable cut design, even in the modern era (see, e.g., Huisman and Huisman, 1966; Polakiewicz, 1973; Watermeyer, 1974), but he is rightly credited with awakening the trade to the importance of protecting one’s rights to a valuable cut. Indeed, there were more cut patents issued in 2002 alone than in all the years before Grossbard patented the Radiant.

THE CURRENT STATUS OF PROPRIETARY CUTS IN THE MARKET

Scope. In late 2002, the author conducted a comprehensive search of the trade literature, USPTO, EPO, and WIPO patent and trademark databases, and the Internet to compile a list of as many proprietary cuts placed on the market in the past three decades

Figure 10. Leon Finker’s Trillion and Henry Grossbard’s Radiant cuts were two of the most important proprietary cuts of the 1970s. Grossbard patented his design and registered the brand name, but Finker’s failure to do the same contributed to his loss of control over both the name and the design. The trillion-cut diamond weighs 1.25 ct; the radiant, 2.83 ct. Photo by Maha Tannous.



as possible, and to determine their status as patented and/or trademarked property. No distinctions were made for popularity, even though some cuts included in the study are now unlikely to be seen anywhere but in estate pieces. However, branded fancy cuts that have entered the public domain through manufacturer choice (such as the De Beers/Tolkowsky Flower cuts) or the passage of time (as with Grossbard's Radiant and Watermeyer's Barion) were not considered.

The research also did not include every active U.S. gemstone patent, since many more cut patents exist than could be matched to known branded products. Rather, it was limited to cuts that the author was able to confirm have been placed on the market. (Several diamond manufacturers, notably Ambar Diamonds of Los Angeles and M. Fabrikant & Sons of New York, hold half a dozen or more patents for cuts that apparently are not yet being sold [Ambar, 1998a–g, 1999; Freilich, 2000a–d]. Some of these may be protective patents intended to deter unauthorized modifications of an established, patented design such as Ambar's Quadrillion.)

The research was further restricted to cuts intended for diamonds; patents that described cuts for colored stones or ornamental crystal were not included. In some cases, it was not clear whether the cut was designed for a specific stone, and the inclusion or exclusion thereof reflected the author's judgment based on the specific language of the patent records or other references describing a cut's usage as a diamond design.

A total of 81 proprietary cuts were identified. A complete list of the specific cuts, their manufacturers and descriptions, and their individual patent and trademark status, is given in Appendix 1.

Methods. Trademark status was based on records returned with the USPTO's Trademark Electronic Search Service, the WIPO's Madrid Express Database (<http://www.wipo.int/madrid/en>), and OHIM's Community Trade Mark Consultation Service (http://oami.eu.int/search/trademark/la/en_tm_search.cfm). Patent status was based on records returned from searches of the USPTO's Patent Full-Text and Full-Page Image Database and the EPO's esp@cenet search service (<http://ep.espacenet.com>). (The WIPO maintains a database of PCT applications [<http://ipdl.wipo.int>], but it is currently unofficial and for test purposes only.)

Not all cuts reported as patented in reliable lit-

erature could be located in the USPTO and EPO databases (for example, Diamco's Cushette cut is described in a *Rapaport Diamond Report* piece as being patented ["Cushette Cut," 2002], but the author could not locate any such records; the application may have been filed under a different name or may simply be pending); such cuts are described as "probable" in the Results below. Some brand names had registrations that have since been cancelled or abandoned; these were counted with the never-registered names, since the legal effect is the same.

Results. The research revealed varying attitudes about protecting cut designs. Only a minority of the cuts are known to be protected by both patent and registered trademark (20/81), with four more—all trademarked—probably patented (i.e., reported in the literature as patented, but not appearing in any of the databases). A similar number (25/81) have registered trademarks but no patents, which reflects at least some intent to protect the design (this includes two trademarked cuts for which the patents have expired). Less easy to understand are the nine cuts (plus three probables) that have patents but unregistered trademarks (though such registrations may well be pending). Finally, 20 of the 81 cuts appear to be unprotected by either patent or registered trademark.

DISCUSSION

While there does not appear to be a strong trend toward patenting designs (at most, 36 of the 81 cuts had patents, and the actual number is probably lower), the manufacturer names that accompany the patented cuts (e.g., Tiffany, Tolkowsky, Goldberg, Schachter) are significant. Whether these manufacturers are the vanguard of a trend, or the patented status of their cuts simply reflects the greater resources they can bring to protecting a design, is a matter for future attention. It is worth noting, however, that of the 29 cuts for which full patent data could be obtained, a large majority (21/29) have been patented in the last four years, and all but one have been patented in the last 10 years. Patenting a cut may not (yet) be the rule, but the pace of it is clearly accelerating.

A stronger trend toward registering trademarks was apparent, with 49 of the 81 cuts having registered brand names. From this, it is clear that the trade views protection of a brand name as more

important than protection of a cut design. This trend is more significant when the following issue is considered.

Because the intent of this study was to determine the treatment of designs that *could be patented*, it did not focus on branded versions of the traditional 57/58-facet round brilliant. However, the trend toward branding round brilliants is at least as strong as any trend toward branding new cuts. *Modern Jeweler's* most recent annual survey of diamond branding, for example, lists 23 "ideal"-cut brand names alone (see "Who's who..." 2002), of which 15 were registered trademarks.

These results are consistent with attitudes reported in the trade literature. Many manufacturers take the position that a trademark alone (even an unregistered one) is enough to establish a cut in the market and protect it from unauthorized duplication (see, e.g., Scriven, 1997; Shor, 1997). The weaker interest in patents reflected in the study is mirrored by frequent trade concerns—which have some validity—that patent protections can be evaded by making minor changes in a duplicated design (R. Shor, pers. comm., 2002). Nor is it difficult to find manufacturers willing to dismiss the idea of intellectual property protection altogether, reasoning that quality of the polished diamond alone is enough to establish a brand in the mind of the consumer (Scriven, 1997).

In the days when the product was more important than the brand name, such attitudes could probably be excused. As diamond branding becomes more and more important, however, protecting one's brand (by all available methods) evolves from a matter of personal preference to one of survival.

While the value of protecting a hard-earned brand name should be self-evident, design protections should not be dismissed either. It is true that proprietary designs typically occupy a small fraction of the total diamond market (see Even-Zohar, 2002), but any design worth the effort of creation and marketing is a design worth protecting. Indeed, the cut may attract little attention; then again, it may be the next Trillion or Radiant. In the former case, inattention to legal niceties is of little import; in the latter, it could prove very costly indeed.

CONCLUSION

Establishing and protecting branded cuts and cut brand names promises to be one of biggest issues in the diamond trade in the near future. The distinctions between trademark, which protects only the brand name, and patent, which protects the design itself, are important. Though these protections have existed for many years, the history of diamond cut patents reflects only spotty interest until recent decades.

A review of the current market indicates that the registered trademark remains the preferred method of protecting a new proprietary diamond cut, though a smaller, but accelerating, number of manufacturers and retailers are taking the further step of patenting their designs. As the diamond industry grows increasingly competitive in response to changes in the diamond pipeline, and as branding becomes the rule for manufacturers and retailers rather than the exception, the protections afforded by patent and trademark promise to become more attractive in the years to come.

ABOUT THE AUTHOR

Mr. Overton is managing editor of *Gems & Gemology* at GIA in Carlsbad, California, and is a licensed attorney and a member of the Intellectual Property Section of the State Bar of California.

ACKNOWLEDGMENTS

Glenn Meyer, Cathy Jonathan, and Dona Dirlam, of the Richard T. Liddicoat Library and Information Center at GIA in Carlsbad, provided considerable assistance in researching this article. The author is also indebted to Nicholas Delre of the European

Gemological Laboratory, New York, for his prior work in compiling gemstone and jewelry patent records; to Russell Shor of GIA in Carlsbad for providing insights into the current state of the diamond trade; to Dr. Karl Schmetzer of Petershausen, Germany, for helpful information about international patent procedures; and to Carol Stockton, technical editor of *Gems & Gemology*, for assistance with analyzing research data.

NOTE: This article is intended for informational purposes only and should not be used as legal advice. Readers desiring more information on these subjects should consult a qualified attorney.

Appendix 1: Proprietary/patented diamond cuts.^a

Name	Description	Patent ^b	® Trademark ^c	Inventor/owner	References
Amity	29-facet square		No	Emdico, London	Emdico, 2002
Ashoka	62-facet modified antique cushion	2002	Yes	William Goldberg, New York	"The Ashoka cut," 1999; Goldberg, 2002
Asprey	61-facet cushion		Yes	Gabriel Tolkowsky/Asprey, London	"Asprey cut," 2002
Aster	73-facet modified round brilliant		Yes	Rosy Blue Int'l, Antwerp	Moses and Reinitz, 2002
Baguillion	Brilliant-cut baguette	No	Yes	Baguette World, Los Angeles	<i>GIA Diamond Dictionary</i> , 1993; "Baguillion," 1998; "Who's who..." 2002
Barocut	Rectangular modified brilliant	2001	Yes	Baroka Creations, New York	Rokah, 2001
Baroness	Octagonal modified brilliant	No	Yes	Raphaeli Stschik, Israel	Geolat, 1991; Koivula and Kammerling, 1991b; <i>GIA Diamond Dictionary</i> , 1993
Buddha	56-facet "Buddha"-shaped modified brilliant	+	No	J. Korn & Partners, Antwerp	Johnson and Koivula, 1996; "Buddha cut," 1998
Butterfly	Butterfly shaped	2000	No	Guy Couture/Papillion Gemme, Montreal	Couture, 2000; "Branded diamonds," 2002
Centillion	100-facet modified round brilliant	Expired	Yes	Jules Polakiewicz	Polakiewicz, 1973
Century Cut	66-, 74-, or 90-facet modified round brilliant	+	Yes	C. Kirk Root Designs, Austin, Texas	C. Kirk Root Designs, 2002
Context Cut	Octahedral modern point	1995	Yes	Freiesleben, Antwerp	Freiesleben, 1995; Kammerling et al., 1995
CrissCut	77-facet modified emerald, triangular pavilion facets	1998	Yes	Christopher Slowinski, New York	Slowinski, 1998; Misiorowski, 2000; "Who's who..." 2002
Crossfor	46-facet modified square brilliant	2000	No	Crossfor Diamond Co., Japan	Dobashi, 2000; "Branded diamonds," 2002
Cubicle Cut	9-facet square		No	August Mayer, Germany	"Optical illusion..." 2002
Cushette	Brilliant-cut cushion	+	Yes	Diamco, New York	"Cushette cut," 2002; "Who's who..." 2002
Dene Rose	Modified rose cut	No	No	Unknown/NWT, Canada	"Diamond Facts 2000/01," 2001
Diallenium	96-facet modified round brilliant		No	Orion Diamond, New York	"Branded diamonds," 2002
Diamond Star	66-76 facet five-pointed star	1996	No	Fancoldi, Switzerland	Koivula et al., 1993a; Harris and Harris, 1996
Dream	69-facet modified princess	2002	Yes	Hearts on Fire, Boston	"Branded diamonds," 2002; Rothman, 2002
Duchess	45-facet hexagonal modified marquise	No	Yes	Raphaeli Stschik, Israel	Geolat, 1991; Koivula and Kammerling, 1991b; <i>GIA Diamond Dictionary</i> , 1993
Elara (formerly Flanders)	61- or 65-facet square modified brilliant	+	Yes	Elara Diamonds, New York	Geolat, 1991; Koivula et al., 1993b; "Branded diamonds," 2002
Emdi	41-facet octagonal		No	Emdico, London	Emdico, 2002
Empress	64-facet heptagonal modified pear	No	Yes	Raphaeli Stschik, Israel	Koivula and Kammerling, 1991b; <i>GIA Diamond Dictionary</i> , 1993
Escada	97-facet dodecagon	2002	Yes	Pluczenik, Antwerp	Escada cut, 2001; Stern, 2002
Eternal	81-facet modified round brilliant	1999	Yes	Gabriel Tolkowsky/Garrard, London	Tolkowsky, 1999; Drucker, 2000
Fire and Ice Ideal	"Ideal"-cut princess		Yes ^d	Sirius Diamonds, Vancouver	"Sirius introduces..." 2002
Gabrielle	105-facet modified round brilliant	2002	No ^e	Gabriel Tolkowsky/ /Suberi Bros., New York	Tolkowsky, 2002; "Who's who..." 2002
Gordon's Diamond	73-facet sunburst pattern modified round brilliant		Yes	Zale Corp., Irving, Texas	Beres, 2002
Grace	65-facet shield		Yes	Raphaeli Stschik, Israel	"Grace Cut," 1999
Happyeight Brilliant	Octagonal modified brilliant		No ^f	Kuwayama, Antwerp	Kuwayama, 2002
Heera	49-facet modified round brilliant		No	Emdico, London	Emdico, 2002
Highlight	73-facet modified round brilliant	+	No	Diadenza, Antwerp	Diadenza, 2003
J.C. Millennium	16-sided 89-facet modified round brilliant		Yes	J.C. Millennium Diamonds, Antwerp	Drucker, 2000; "Who's who..." 2002
Jubilant Crown	Modified round brilliant, 16 extra crown facets	2001	Yes	Edwin Bruce Cutshall, Virginia	Cutshall, 2001; "Introducing the patented Jubilant Crown diamond," 2002
Juliette	Half-oval brilliant	No	No	Mark Silverstein, New York	"Who's who..." 2002
King	86-facet modified round brilliant	No	No	King Diamond Cutters, New York	<i>GIA Diamond Dictionary</i> , 1993
Leo	65-facet modified round brilliant	1999	Yes	Leo Schachter Diamonds, New York	Namdar et al., 1999; "Branded diamonds," 2002
Lily Cut	Flower-shaped, four "petals," square table, 65 facets	1997	Yes	Lili Diamonds, Israel	"New Lily Cut ...," 1997; Siman-Tov et al., 1997; "Who's who..." 2002
Linz	Modified princess		Yes	Zale Corp, Irving, Texas	Beres, 2002
Lion	Modern rose-cut round brilliant		No ^g	Paul De Maere, Antwerp	"Table-less diamond..." 2002
Lucère (American)	65-facet modified princess		Yes	Ernest Slotar Inc., Chicago	"Who's who..." 2002
Lucère (European)	As Lucère (American), with 16 extra crown and 4 extra pavilion facets		Yes	Ernest Slotar Inc., Chicago	"Who's who..." 2002
Lucida	50-facet cut-cornered princess	2002	Yes	Tiffany & Co., New York	"Branded diamonds," 2002; Greeff, 2002 a, b
Magna	102-facet modified round brilliant	No	No	Unknown	<i>GIA Diamond Dictionary</i> , 1993
Marquise Dream	Hexagonal modified marquise		No	Michael Schlacter/Maico Diamond, New York	Geolat, 1991; Koivula and Kammerling, 1991a

Name	Description	Patent ^b	® Trademark ^c	Inventor/owner	References
Millennial Sunrise	43-facet, 7-table oval		No	USA Studs, New York	Drucker, 2000
Millennium	Modified emerald with faceted table		No	Harrod's Diamonds, London	"Modified emerald cut...", 1998
New Century	101-facet modified round brilliant	1999	No	Michael Parker, Honolulu	Parker, 1999
Noble	29-facet step-cut kite		No	Doron Isaak, Beverly Hills	"Who's who...", 2002
Octillion	Octagonal modified brilliant	2001	Yes	M. Fabrikant & Sons, New York	Turner and Courtney, 2001
Octus	56-facet octahedron	2000	Yes	Bunz, Germany	Bunz, 2000
Oval Dream	Octagonal modified oval		Yes	Michael Schlacter/ Maico Diamond, New York	Geolat, 1991; Koivula and Kammerling, 1991a
Pear Dream	Heptagonal modified pear		Yes	Michael Schlacter/ Maico Diamond, New York	Geolat, 1991; Koivula and Kammerling, 1991a
Petar	Square modified brilliant		No	Petar's Jewelry, Ontario, Canada	"Controversy...", 1989
Phoenix	85- to 89-facet modified round brilliant		Yes	Kristal/Phoenix Diamond, New York	"Who's who...", 2002
Princette	48-facet princess-cut baguette		Yes	Mark Silverstein, New York	"Princette," 1998; "Who's who...", 2002
Quadrillion (new)	Modified princess	2000	Yes	Ambar Diamonds, Los Angeles	Ambar, 2000; "Branded diamonds," 2002
Queen of Hearts	Square modified brilliant		Yes	Horowitz & Atlass, New York	Weldon, 2002
Queen's Cut	60-facet modified oval brilliant	1996	Yes	Henry Grossbard	Grossbard, 1996
Radiant (modified)	Cut-cornered, rectangular/square modified brilliant	1985	No	Henry Grossbard	Grossbard, 1985; "Who's who...", 2002
Regent	12-sided modified round brilliant		Yes	Horowitz & Atlass, New York	Weldon, 2002
Royal Asscher	74-facet modern Asscher (step-cut square)	2002	Yes	Royal Asscher Diamond Co., Amsterdam	"The Royal Asscher cut," 2001; Asscher, 2002
Royal Brilliant 82	82-facet modified round brilliant	+	Yes	Royal Brilliant Co.	"Who's who...", 1997
RoyalCrest	Checkerboard crown, step-cut rectangular	1996	Yes	Merit Diamond Corp., New York	Kaplan, 1996; "Who's who...", 2002
Scottish	Modified round brilliant showing St. Andrew's Cross on pavilion		No	Alison and Roy Murray, Durham, Scotland	"Scottish cut," 2000
Shiva	89-facet modified round brilliant		No	Erdico, London	Erdico, 2002
SkyStar	Flower-shaped, four pointed "petals"	1998	No ^g	Lili Diamonds, Israel	Siman-Tov et al., 1998
Spirit of Flanders	80-facet modified round brilliant		Yes	Diamwag, Antwerp	"Branded diamonds," 2002
Spirit Sun	Triangular-facet dual-pavilion round	1997	Yes	Freiesleben, Antwerp	Kammerling et al., 1995; Freiesleben, 1997
Spring	Rectangular modified brilliant		No	Whiteflash, Houston, Texas	Weldon, 2002
StarBurst	95- to 110-facet rectangular modified brilliant		Yes	Louis Glick & Co., New York	Geolat, 1991; "Who's who...", 2002
Torus	Doughnut-shaped round	1998	No	Glenn W. Lehrer, San Rafael, CA	Lehrer, 1998
Trapeze	48-facet brilliant-cut baguette	1994	No	Stephen Baker (Schlomo Bachar), New York	Federman, 1991; Bachar, 1994
Trielle	50-facet triangular modified brilliant	Expired	Yes	Trillion Diamond Co., New York	Finker and Finker, 1978; "Who's who...", 2002
Trilliant	44-facet triangular modified brilliant	No	No ^h	Henry Meyer, New York	Geolat, 1991; "Who's who...", 2002
Tycoon	Rectangular, 9-facet crown, step-cut pavilion	2002	Yes	Tycoon, Los Angeles	Johnson and Koivula, 2000; Kejejian, 2002; "Who's who...", 2002
Ultimate	64-facet baguette	+	No ^f	Stephen Baker, New York	"The Ultimate cut...", 2003
Victorian	Octagonal step cut		Yes	ABA Diamond Corp., New York	"Victorian cut," 2002
Zales Diamond	Octagonal modified brilliant	No	Yes	Zale Corp., Irving, Texas	"Branded diamonds," 2002
Zoë Cut	100-facet modified round brilliant	2001	Yes	Gabriel Tolokowsky/ Suberi Bros., New York	Tolokowsky, 2001; "Who's who...", 2002

^aBecause this table is limited to designs that could be patented, it does not include branded versions of the traditional 57/58-facet round brilliant. It is also limited to cuts patented since 1970 and to cuts that have not yet entered the public domain (whether through the passage of time or manufacturer choice).

^bYears given are the effective date of the patent, if any. A plus sign (+) means the author believes the cut is patented, based on reference(s) listed, but could not confirm that fact by searching U.S. patent records. A blank line means the author believes the cut is not patented, based on patent searches and reference(s) listed, but could not confirm that fact through other research. Patent data are as of October 2002. See References for specific patent numbers.

^cTrademark registration data as of October 2002. "Yes" entries include active applications in addition to registrations. Entries marked "no" include expired, cancelled, and abandoned marks in addition to marks never registered.

^dThe trademark held by Sirius is actually "Arctic Fire and Ice Diamonds." "Fire & Ice" is held by another party.

^eManufacturer claims a registration, but USPTO records show it as abandoned.

^fManufacturer claims a registration, but no records were returned from USPTO or WIPO databases.

^gThe term is registered by Bulova for watches, but not for a diamond cut.

^hThe term is registered by Henry Meyer & Co. as part of a logo but not for a diamond cut.

REFERENCES¹

- Ambar B. (1998a) *Gemstone*. U.S. patent D395,844, issued July 7.
- (1998b) *Gemstone*. U.S. patent D397,954, issued September 8.
- (1998c) *Gemstone*. U.S. patent D400,470, issued November 3.
- (1998d) *Gemstone*. U.S. patent D400,817, issued November 10.
- (1998e) *Gemstone*. U.S. patent D400,819, issued November 10.
- (1998f) *Gemstone*. U.S. patent D401,183, issued November 17.
- (1998g) *Gemstone*. U.S. patent D402,582, issued December 15.
- (1999) *Gemstone*. U.S. patent D405,712, issued February 16.
- (2000) *Gemstone*. U.S. patent D420,935, issued February 22.
- The Ashoka cut (1999) *Rapaport Diamond Report*, Vol. 22, No. 28, p. 95.
- Asprey cut (2002) *Rapaport Diamond Report*, Vol. 25, No. 29, p. 125.
- Asscher E. (2002) *Diamond*. U.S. patent D453,007, issued January 22.
- Asscher M.J. (1902). France patent 324,092, issued August 28.
- Bachar S. (1994) *Gemstone*. U.S. patent D350,708, issued September 20.
- Baguillion (1998) *Rapaport Diamond Report*, Vol. 21, No. 34, p. 76.
- Beres G. (2002) Something old, something new. *New York Diamonds*, September, pp. 16–18.
- Branded diamonds (2002) Keyguide Trade Directory for diamonds and the diamond business and industry, <http://www.diamond-key.com/> [accessed September 20, 2002].
- Bruton E. (1970) *Diamonds*. Chilton Book Co., Philadelphia, Pennsylvania.
- Buddha cut (1998) *Rapaport Diamond Report*, Vol. 21, No. 45, p. 101.
- Bunz G. (2000) *Polished Gemstone*. U.S. patent 6,029,474, filed August 13, 1998.
- C. Kirk Root Designs (2002) About Kirk Root, <http://www.kirkrootdesigns.com/html/about.htm> [accessed October 4, 2002].
- Caspi A. (1997) Modern diamond cutting and polishing. *Gems & Gemology*, Vol. 33, No. 2, pp. 102–121.
- Code of Federal Regulations, Title 37 (Patents, Trademarks, and Copyrights). Available online at <http://www.uspto.gov/web/offices/tac/tmlaw2.html>.
- Controversy around new Flanders cut (1989) *Diamond Intelligence Briefs*, October 27, p. 547.
- Cottier J.G.C. (1890) *Precious or Imitation Stone*. U.S. patent D20,043, issued July 22.
- Couture G. (2000) *Butterfly Gem*. U.S. patent 6,158,243, filed June 10, 1998.
- Cushette cut (2002) *Rapaport Diamond Report*, Vol. 25, No. 35, pp. 108–109.
- Cutshall E.B. (2001) *Crown of a Round Faceted [sic] Gemstone*. U.S. patent D444,097, issued June 26.
- De Beers Industrial Diamonds, Spits R.A., Burns R., Fisher D. (2001a) *High Temperature/High Pressure Colour Change of Diamond*. International (PCT) patent application WO 01/72404A1, filed April 2.
- (2001b) *High Temperature/High Pressure Colour Change of Diamond*. International (PCT) patent application WO 01/72405A1, filed April 2.
- (2001c) *High Temperature/High Pressure Colour Change of Diamond*. International (PCT) patent application WO 01/72406A1, filed April 2.
- Diadanza (2003) The Highlight cut, <http://www.diadanza.com/products.html> [accessed January 6, 2003].
- Diamond Facts 2000/01* (2001) Northwest Territories Resources, Wildlife and Economic Development.
- Dobashi H. (2000) *Gemstone*. U.S. patent D426,488, issued June 13.
- Donahue W.H. (2001) Appeals court reverses Yurman trade dress win, upholds copyright finding. *Professional Jeweler*, Vol. 4, No. 11, pp. 102–103.
- Drucker R.B. (2000) Everyone's branding diamonds! *Jewelers' Circular Keystone*, Vol. 171, No. 7, pp. 132–135.
- Emdico (2002) Latest market trends on gems, jewellery, precious, and semi precious stones, <http://www.emdico.co.uk/newarrival.asp> [accessed October 11, 2002].
- Escada cut (2001) *Rapaport Diamond Report*, Vol. 24, No. 9, p. 111.
- Even-Zohar C. (2002) The battle of the brands will transform the industry rough supply structures. *Mazal U'Bracha*, Vol. 17, No. 142, pp. 61–67.
- Even-Zohar C., Moderator (1999) Diamond Cut War Room. Proceedings of the Third International Gemological Symposium, *Gems & Gemology*, Vol. 35, No. 3, pp. 134–135.
- Federman D. (1991) New diamond cuts: Fancies freed. *Modern Jeweler*, Vol. 90, No. 5, pp. 44–52.
- Finker L., Finker M. (1978) *Precious, Semiprecious or Synthetic Cut Stone*. U.S. patent D250,100, issued October 31.
- Freiesleben U. (1995) *Cut Diamond*. U.S. patent 5,454,235, filed May 4, 1994.
- (1997) *Cut Diamond*. U.S. patent 5,657,647, filed July 26, 1995.
- Freilich J. (2000a) *Gem Cut*. U.S. patent D419,103, issued January 18.
- (2000b) *Gem Cut*. U.S. patent D419,909, issued February 1.
- (2000c) *Gem Cut*. U.S. patent D422,238, issued April 4.
- (2000d) *Gem Cut*. U.S. patent D434,692, issued December 5.
- Geolat P. (1991) Cuts: Patented & trademarked. *Jewelers' Circular Keystone*, Vol. 162, No. 10, pp. 58–61.
- GIA Diamond Dictionary* (1993) 3rd ed. Gemological Institute of America, Santa Monica, California.
- Goldberg S. (2002) *Jewelry Stone*. U.S. patent D459,268, issued June 25.
- Goldstein E. (1944) *Precious Stone*. U.S. patent 2,340,659, issued February 1, 1943.
- Grace cut (1999) *Rapaport Diamond Report*, Vol. 22, No. 46, p. 123.
- Greeff R.S. (2002a) *Cut Cornered Square Mixed-Cut Gemstone*. U.S. patent 6,363,745, filed August 12, 1999.
- (2002b) *Gemstone*. U.S. patent D463,315, issued September 24.
- Grossbard H. (1977) *Brilliantized Step-Cut Diamond*. U.S. patent 4,020,649, issued May 3.
- (1985) *Step-cut Stone Which Has Been Brilliantized*. U.S. patent 4,555,916, issued December 3.
- (1996) *Diamond*. United States patent D366,628, issued January 30.
- Harris H.B., Harris H.J. (1996) *Diamond*. U.S. patent D375,914, issued November 26.
- Hazard J.W. (2001) *Copyright Law in Business and Practice*. West Group, New York.
- Hopkins S. (1790) U.S. patent X1, issued July 31.
- Huisman J., Huisman H. (1966) *Diamond with Specially Faceted Pavilion*. U.S. patent 3,286,486, issued November 22.
- Introducing the patented jubilant crown diamond (2002) <http://www.huntcountry.com/jubpg.htm> [accessed September 25, 2002].
- Jassin L.J., Schechter S.C. (2000) *Copyright Permission & Libel Handbook*. John Wiley & Sons, New York.
- Johnson M.L., Koivula J.L., Eds. (1996) Gem News: Diamond novelty cut as seated Buddha. *Gems & Gemology*, Vol. 32, No. 3, p. 215.
- (2000) Gem News: New diamond cut: "Tycoon" cut. *Gems & Gemology*, Vol. 36, No. 2, p. 160.
- Kammerling R.C., Koivula J.L., Fritsch E., Eds. (1995) Gem News: New diamond cuts. *Gems & Gemology*, Vol. 31, No. 1, pp. 59–60.
- Kaplan G. (1996) *Cut for a Diamond Gem*. U.S. patent D365,780, issued January 2.
- Kejajian T. (2002) *Diamond Cut*. U.S. patent 6,449,985, filed

¹ The reference dates for patents vary because the term of the patent may run from either the filing date or the issue date, depending on when the application was filed.

- September 14, 2000.
- Kekahbah J.M. (2000) Both sides appealing judge's ruling in Yurman vs. PAJ. *Gemkey*, July 6 [on file with author].
- Koivula J.I., Kammerling R.C., Eds. (1991a) Gem News: New diamond cuts. *Gems & Gemology*, Vol. 27, No. 3, p. 181.
- (1991b) Gem News: New "Royal" diamond cuts. *Gems & Gemology*, Vol. 27, No. 4, pp. 255–256.
- Koivula J.I., Kammerling R.C., Fritsch E., Eds. (1993a) Gem News: Star-cut diamonds. *Gems & Gemology*, Vol. 29, No. 1, p. 52.
- (1993b) Gem News: "Flanders Brilliant" cut debuts in U.S. *Gems & Gemology*, Vol. 29, No. 2, pp. 130–131.
- Kuwayama (2002) Happyeight brilliant, <http://www.flanders-brilliant.be/happyo.htm> [accessed October 8, 2002].
- Lamb-Weston (2002) Lambweston—Specialty cuts: CrissCut, <http://www.lambweston.com/products.asp?pid=S15&navid=11&chain=2,11> [accessed October 4, 2002].
- Lehrer G.W. (1998) *Torous* [sic] *Ring Gemstone and Method for Making Same*. U.S. patent 5,722,261, filed December 30, 1996.
- Misiorowski E. (2000) Jewelry of the 1990s. *Gems & Gemology*, Vol. 36, No. 4, pp. 398–417.
- Modified emerald cut helps conceal small flaws (1998) *Jewellery News Asia*, No. 172, p. 150.
- Moses T., Reinitz I. (2002) Gem News International: New round diamond cuts. *Gems & Gemology*, Vol. 38, No. 2, pp. 173–174.
- Namdar A., Azoulay D., Levy S., Bartal Y. (1999) *Gem Stone*. U.S. patent D412,136, issued July 20.
- New Lily cut has 65 facets (1997) *Jewellery News Asia*, No. 149, p. 130.
- Optical illusion highlighted in new cut (2002) *Jewellery News Asia*, No. 216, p. 54.
- Paris Convention for the Protection of Industrial Property (1979) Available online at <http://www.wipo.int/clea/docs/en/wo/wo020en.htm>.
- Parker M.D. (1999) *Diamond Cut*. U.S. patent D414,133, issued September 21.
- Polakiewicz J. (1973) *Brilliant with Octagonal Table and Surrounding Trapezoidal Facets*. U.S. patent 3,763,665, issued October 9.
- Prahl D. (2002) The Madrid Protocol: International trademark protection for United States trademark owners. *27th Annual Intellectual Property Institute*, State Bar of California, San Francisco, Chap. 19.
- Princette (1998) *Rapaport Diamond Report*, Vol. 21, No. 34, p. 76.
- Rokah N. (2001) *Rectangular Cut Diamond*. U.S. patent D447,083, issued August 28.
- Rothman G. (2002) *Diamond*. U.S. patent D465,430, issued November 12.
- The Royal Asscher cut (2001) *Rapaport Diamond Report*, Vol. 24, No. 20, p. 125.
- Schenck E.G.H. (1902a) *Cut Stone*. U.S. patent D35,937, issued June 10.
- (1902b) *Cut Stone*. U.S. patent D35,938, issued June 10.
- (1906) *Diamond*. U.S. patent 809,531, issued January 9.
- (1941) *Cut Stone*. U.S. patent 2,265,316, issued December 9.
- Schmetzer K. (2002) Hochdruck-Hochtemperatur-Behandlung natürlicher Diamanten. *Goldschmiede Zeitung*, Vol. 100, No. 1, p. 92.
- Scottish cut (2000) *RJ*, February (advertising insert).
- Scriven S. (1997) Brand name diamonds: The strategic future of diamond marketing. *Mazal U'Bracha*, Vol. 14, No. 97, pp. 43–48.
- Shor R. (1997) Smorgasbord. *Jewelers' Circular Keystone*, Vol. 168, No. 8, pp. 80–84.
- (2001) Branding is here to stay. *In-Sight*, Summer, pp. 10–11.
- Sielaff G.W. (1991) Trillion diamond to get new name. *National Jeweler*, Vol. 35, No. 6, p. 3.
- Sielaff W., Moderator (1999) Branding War Room. Proceedings of the Third International Gemological Symposium, *Gems & Gemology*, Vol. 35, No. 3, pp. 130–131.
- Siman-Tov J., Siman-Tov I., Siman-Tov A. (1997) *Flower-shaped Cut Diamond*. U.S. patent D384,592, issued October 7.
- (1998) *Flower-shaped Cut Diamond*. U.S. patent D398,552, issued September 22.
- Sirius introduces new brands at AGS Conclave (2002) *National Jeweler*, Vol. 96, No. 10, p. 28.
- Slowinski C. (1998) *Gemstone*. U.S. patent D391,518, issued March 3.
- Spencer K.Y. (2002) The nuances of international design protection. *27th Annual Intellectual Property Institute*, State Bar of California, San Francisco, Chap. 9.
- Stern M. (2002) *Diamond*. U.S. patent D457,090, issued May 14.
- Table-less diamond vies for "most beautiful" status (2002) *National Jeweler*, Vol. 96, No. 8, p. 30.
- Tillander H. (1995) *Diamond Cuts in Historic Jewelry*. Art Books International, London.
- Tolkowsky A., Tolkowsky M., Tolkowsky I. (1903) *Cut Stone*. U.S. patent D36,340, issued June 2.
- Tolkowsky G. (1999) *Precious Stone*. U.S. patent D415,712, issued October 26.
- (2001) *Precious Stone*. U.S. patent D439,196, issued March 20.
- (2002) *Precious Stone*. U.S. patent D463,312, issued September 24.
- Townsend D.C. (1902) *Diamond*. U.S. patent 693,084, issued February 11.
- Trillion Diamond Co. announces new name for diamond: Trielle (1991) *National Jeweler*, Vol. 35, No. 9, p. 2B.
- Turner D.W., Courtney R.F. (2001) *Gemstone*. U.S. patent D439,542, issued March 27.
- The Ultimate cut engagement jewelry collection (2003) <http://www.sbtrapeze.com/trap-200.html> [accessed January 6, 2003].
- Uniform Trade Secrets Act (1985). Available online at <http://www.law.upenn.edu/bll/ulc/fmact99/1980s/utsa85.htm>.
- United States Code, Title 15: Trademarks, Sections 1051–1129. Available online at <http://uscode.house.gov/download/15c22.doc>.
- United States Code, Title 17: Copyright, Sections 100–1332. Available online at <http://www.copyright.gov/title17/index.html>.
- United States Code, Title 35: Patents, Sections 100–376. Available online at http://www.uspto.gov/web/offices/pac/mpep/consolidated_laws.pdf.
- Victorian cut (2002) *Rapaport Diamond Report*, Vol. 25, No. 29, p. 123.
- Watermeyer B. (1974) *Stone with Emerald Cut Crown and Modified Brilliant Cut Base*. U.S. patent 3,796,065, issued March 12.
- Weldon R. (2002) Fab four. *Professional Jeweler*, Vol. 5, No. 11, p. 18.
- Who's who in brand name diamonds (1997) *Modern Jeweler*, Vol. 96, No. 6, pp. 65–87.
- Who's who in premium diamonds (2002) *Modern Jeweler*, Vol. 101, No. 5, pp. 94–110.
- World Intellectual Property Organization (2001) Member states agree to move ahead with efforts to harmonize trademark law. *WIPO Update*, No. 154/2001, <http://www.wipo.int/pressroom/en/updates/2001/upd154.htm>.
- (2002a) Basic facts about the Patent Cooperation Treaty (PCT). http://www.wipo.int/pct/en/basic_facts/basic_facts.pdf.
- (2002b) Guide to the international registration of marks under the Madrid Agreement and the Madrid Protocol. <http://www.wipo.int/madrid/en/guide/>.
- Wueste R.J. (2002) *Brilliant-cut Diamond and Method of Forming Thereof*. U.S. patent application 20020162356, filed February 25.

RHODIZITE-LONDONITE FROM THE ANTSONGOMBATO PEGMATITE, CENTRAL MADAGASCAR

By Brendan M. Laurs, Federico Pezzotta, William B. (Skip) Simmons, Alexander U. Falster, and Sam Muhlmeister

Londonite was approved as a new mineral species in 1999. This rare aluminum-beryllium borate is the cesium-rich analogue of rhodizite; the two end members can be separated only through quantitative chemical analysis. The only known source of gem-quality londonite is the Antsongombato pegmatite in central Madagascar, from which at least 300 carats of rhodizite-londonite have been faceted. The gemstones are colorless to greenish yellow, with an R.I. range of 1.689–1.691, S.G. of 3.34–3.42, and yellowish green fluorescence to short-wave UV. Internal features include partially healed fractures and conspicuous growth zoning that typically correlates to areas of anomalous birefringence. Some near-colorless rhodizite-londonite from Antsongombato has been irradiated to greenish yellow or yellow using X-rays. Both natural-color and irradiated rhodizite-londonite will fade on prolonged exposure to sunlight.

Rhodizite is a rare aluminum-beryllium borate— $(K,Cs)Al_4Be_4(B,Be)_{12}O_{28}$ —that is known only from three countries: Russia (Rose, 1834, 1836), Madagascar (Lacroix, 1910, 1922; Duparc et al., 1911), and the U.S. (Falster and Simmons, 1989). Recently a cesium (Cs)-rich analogue of rhodizite was recognized and named londonite after Dr. David London at the University of Oklahoma, in honor of his contributions to the study of granitic pegmatites. Londonite was approved by the International Mineralogical Association's Commission on New Minerals and Mineral Names in 1999, and described in the literature two years later (Simmons et al., 2001). So far, londonite has been identified only at three pegmatite mines in Madagascar, but gem-quality rhodizite-londonite is known from just one deposit: the Antsongombato pegmatite in the Betafo region. Approximately 300 carats of near-colorless to greenish yellow rhodizite-londonite gemstones (see figures 1 and 2) have been faceted since mining began in October 1998. The attractive appearance and significant hardness (8 on the Mohs scale; Simmons et al., 2001) of the gemstones make them appropriate for jewelry use (again, see figure 1).

This article reports on the history, geology, and mining—as well as the gemological characteristics—of rhodizite-londonite from Antsongombato. One of the authors (FP), who has had extensive first-hand experience with the deposit since 1998, is responsible for much of the unattributed information on the history, mining, and production of the gem material. Since gems with a saturated yellow color are more desirable for jewelry use than pale-colored material, two of the authors (WBS and FP) collaborated on a simple irradiation procedure that is also reported in this article. Note that quantitative chemical analysis is required to differentiate between rhodizite and londonite (as with, for example, elbaite and liddicoatite tourmaline): When cesium (Cs) is the dominant alkali element present, the mineral is londonite; when potassium (K) is more abundant, the species is rhodizite. Therefore, we will refer to the material as *rhodizite-londonite* where the species has not been determined chemically.

See end of article for About the Authors and Acknowledgments.
GEMS & GEMOLOGY, Vol. 38, No. 4, pp. 326–339.
© 2002 Gemological Institute of America



Figure 1. Although rare in gem quality, a significant amount of facet-grade rhodizite-londonite was recently recovered from Antsongombato, Madagascar. This ring by Massimo Novaga features a natural-color rhodizite-londonite that weighs 1.18 ct. Photo by R. Appiani; Pyramide Co. collection.



Figure 2. At 2.02 ct, this is one of the finest examples of faceted natural color rhodizite-londonite seen by the authors. Such material is known only from the Antsongombato pegmatite in central Madagascar. Photo by R. Appiani; Riccardo Caprilli collection.

HISTORY

Although rhodizite has been known as a mineral species for almost 170 years (Rose, 1834), it was not described from Madagascar until much later (Duparc et al., 1910). Today, Madagascar is the only known source of gem-quality rhodizite and londonite. Lacroix (1922) reported colorless to yellow or pale green crystals of rhodizite up to 2 mm wide from the Sahatany Valley (about 35 km east of Antsongombato; figure 3). Mining at the Manjaka pegmatite in the Sahatany Valley during the 1920s is believed to have resulted in some small yellow rhodizites from which stones up to half a carat were faceted. According to local gem dealers, in the 1960s a small quantity of rhodizites up to 2 ct were faceted from colorless to yellow rough obtained from Antsongombato.

The Antsongombato pegmatites have been known since the early 20th century. Duparc et al. (1910) made the first description of the locality, one of 12 tourmaline mines in a series of pegmatites that were worked by French colonists. Attractive gem-quality red tourmaline was mined from massive quartz in the core of the pegmatites or, rarely, from miarolitic cavities. According to local gem traders, these mines and the village of Antsongombato were abandoned, probably in the early 1930s, for unknown reasons; therefore, they do not appear on the geologic map of the area published in 1954 by French geologist A. Emberger.

Behier (1960) specifically mentioned rhodizite from Antsongombato, as well as from two additional localities: Ambalalehifotsy (central Madagascar) and

Anjahamiary (southern Madagascar). In 1964–65, a French colonist organized mining for rhodizite mineral specimens at Antsongombato. Some good specimens were recovered, including a particularly fine, large (about 7 cm across), and vitreous pale yellow crystal of rhodizite-londonite that is in the collection of the Museum of the School of Mines in Paris. According to local dealers, Antsongombato was worked for red tourmaline for a short period in 1978, until the mine was abandoned due to flooding.

During recent field studies (1995–present) of pegmatites in central Madagascar, one of the authors (FP) visited the rhodizite locations mentioned in the literature (i.e., Lacroix, 1910, 1922; Boulanger, 1958; Behier, 1960; Lefevre and Thomas, 1998) and helped discover several new occurrences (Pezzotta et al., 1998; Falster et al., 1999; Pezzotta, 2001). Antsongombato was recognized as having the best potential. In October 1998, investigations by FP revealed a new system of pegmatitic dikes at Antsongombato that were locally mineralized with red tourmaline and yellow Cs-rich rhodizite (later identified as londonite). Mining of one of these pegmatites, referred to as the Antsongombato Gem mine, was quickly organized by the Malagasy company “Pyramide” of Antananarivo. The recovered specimens included a number of well-formed, gem-quality yellow crystals of rhodizite-londonite associated with red tourmaline and blue apatite.

Mining activities stopped in October 2000 after approximately 40 m of the main pegmatite had been penetrated. In January 2001, Pyramide Co. ceased all activities in the area. At the same time, in

collaboration with local Malagasy people, one of the authors (FP) assumed ownership of a series of claims in the Antsetsindrano-Andrembesoa area, including the one containing the Antsongombato Gem mine. Under this ownership arrangement, several local miners (including many former Pyramide Co. workers) currently are prospecting and undertaking small-scale mining of a series of pegmatites that contain rare minerals.

Figure 3. Rhodizite-londonite is known from just three localities (in red), all in central Madagascar. Gem-quality material is known only from Antsongombato. Other pegmatites at Ampanivana and Antandrokombay yield pale-colored crystals that are not transparent enough for faceting. Gem-quality rhodizite (but no londonite) was recently found at a pegmatite near Tetezantsio. Modified from Simmons et al. (2001).



Londonite has also been documented from pegmatites at Ampanivana (15 km to the south) and Antandrokombay (40 km southeast), but no gem-quality material has been found at either locality thus far (Nizamoff et al., 2000; Simmons et al., 2001). Facetable rhodizite was discovered at Tetezantsio (12 km east of Antsongombato) in October 2000, but no londonite has been documented from this locality either (Levinson et al., 2001; Superchi et al., 2001).

LOCATION AND ACCESS

The Antsongombato area is located in the Betafo region in Madagascar's central highlands (again, see figure 3), 4 km east-southeast of the village of Antsetsindrano. The Antsongombato pegmatite is situated on the north side of Manentoakoho Mountain, at an elevation of 1,500–1,600 m (figure 4). Access is via a rough, unpaved road that requires a four-wheel-drive vehicle and takes about 8–10 hours from Antsirabe. The road is not passable during the rainy season (from late November to early May). The rest of the year the area is typically dry. Security is a problem because bandits operate throughout the region.

GEOLOGY

Central Madagascar is characterized by a tectonic unit known as the Itremo thrust sheet (see, e.g., Collins, 2000). Formed by rocks of the Itremo Group, it has a lower unit of gneiss and an upper unit of quartzites, schists, and marbles (Fernandez et al., 2001). Both units are locally intruded by the pegmatites, which probably formed via fractional crystallization of granitic plutons emplaced at relatively shallow depths (Pezzotta and Franchi, 1997).

The Antsongombato region is underlain by crystalline basement rocks of the upper unit of the Itremo Group. The mining area consists of white-to-gray dolomitic marbles and a system of pegmatite dikes that are exposed over a distance of about 1 km. Individual pegmatites can exceed 500 m in length; typically a few tenths of a meter thick, locally they can reach over 6 m. Large, gem-quality crystals of rhodizite-londonite have been produced from only one dike (figure 5), which measures 10–60 cm thick and is about 400 m long (Demartin et al., 2001). Rhodizite-londonite occurs in other pegmatites in the area, but in smaller, lower-quality crystals.



Figure 4. The Antsongombato Gem mine consists of a series of small cuts on the north side of Manentoakoho Mountain, at an elevation of 1,500–1,600 m. Photo by Federico Pezzotta, April 1999.

The pegmatites consist of gray K-feldspar, white to smoky quartz, white albite, polychrome tourmaline, colorless to pink or green spodumene, and a variety of accessory minerals (see Simmons et al., 2001). Micas are absent except in rare areas. The rhodizite-londonite crystals are concentrated in the more chemically evolved portions of the dikes (with green and red tourmaline). Mirolitic cavities are scarce, and rarely exceed a few centimeters in diameter. Although some well-formed

crystals of rhodizite-londonite are found with red tourmaline in these pockets, most are “frozen” within other minerals near the center of the pegmatites. Mining activities have shown that the mineralization is concentrated in coarse-grained “columns” along the dip of the pegmatite. Within these zones, some of the best gem-quality rhodizite-londonite crystals have been found in masses (up to 10+ cm across) composed of fine-grained pollucite and spodumene.

Figure 5. At Antsongombato, gem-quality rhodizite-londonite was mined from a rather narrow (up to 60 cm thick) pegmatite dike by simple hand-digging. A portion of the pegmatite is visible as the steeply dipping dike in the right foreground. Photo by Federico Pezzotta, April 1999.





Figure 6. Well-formed crystals of rhodizite-londonite have been recovered from Antsongombato in relatively large sizes. This exceptional 6.5-cm-wide crystal is shown on a matrix consisting of K-feldspar, albite, and bicolored tourmaline. Photo by Luciano Spezia; Pyramide Co. collection.

MINING

Because of the difficult access to the locality, the shape of the deposit, and its limited production, mining activities have been restricted to hand excavation (again, see figure 5). Organized mining for gem and mineral specimens of rhodizite-londonite began in late 1998, when about 40 miners (orga-

nized in groups of eight) dug several pits into mineralized areas of the pegmatite. The work proceeded carefully to remove the valuable mineral specimens with as little damage as possible. Using pry bars along natural cracks in the rock, the marble host rock was removed first, and then the pegmatites were excavated; no explosives were used. Barren portions of the dike were left in place to provide stability for the excavation. Mining was discontinued during the rainy season.

At the time activities ceased in January 2001, a total of nine mineralized areas had been worked to depths of 35–40 m. In some areas, the mineralization ended at this point; in others, flooding and collapse of some of the pits made continued mining very dangerous. Furthermore, the very hard nature of the unweathered rock at depth would make continued mining difficult. There has been no further mining activity since the deposit was closed, although small amounts of material are periodically released into the market from stock owned by Pyramide Co.

PRODUCTION AND DISTRIBUTION

Most of the gem material and fine mineral specimens were mined from February 1999 to September 2000. Specimens from this production debuted at the 2000 Tucson gem shows, where their high quality and rumored identity as a new mineral created excitement (Moore, 2000). Up to January 2001, the mine yielded several hundred grams of rough gem-quality rhodizite-londonite, from which more than

Figure 7. Twenty-two faceted samples of natural-color rhodizite-londonite (0.09–0.54 ct) were gemologically characterized for this study. They show the range of color that is typically exhibited by the Antsongombato material. Photo by Maha Tannous.

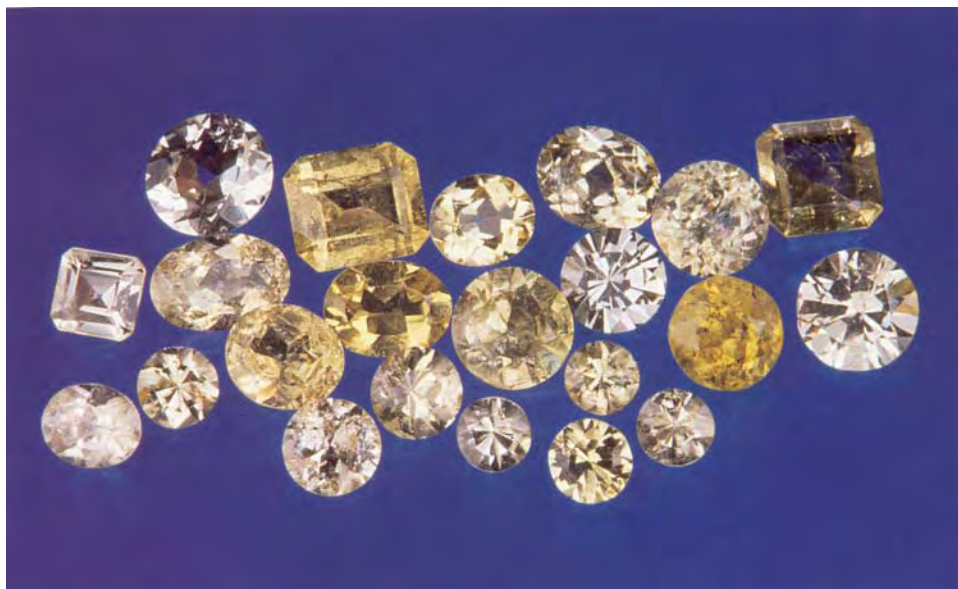

300 carats of faceted gems were obtained. Some were cut in Madagascar, while higher-quality material was sent to Italy for faceting. Most of the gemstones range from 0.5 to 1 ct, although approximately one dozen 1–2 ct stones were faceted. Gemstones exceeding 2 ct are extremely rare, and typically contain abundant inclusions. The majority of the gemstones are moderate to pale greenish yellow; approximately 20% are very pale to near colorless, and less than 15% are saturated greenish yellow. At present, faceted material is sold to gem dealers and collectors by the French venture Polychrome France. Mineral specimens are distributed by the Italian dealer Lino Caserini. Several fine mineral specimens (see, e.g., figure 6) have been sold to major European and U.S. museums.

DESCRIPTION OF THE ROUGH

The rhodizite-londonite crystals from Antsongombato form equant modified dodecahedra that typically measure up to 1 cm, with exceptional specimens up to 6–7 cm. The dominant dodecahedral {110} faces are modified by deltoïd dodecahedral {221}, tristetrahedral {211}, and tetrahedral {111} faces and rare cubic {100} faces (Simmons et al., 2001). A few crystals display only tetrahedral faces and some are perfect octahedra due to combined positive and negative tetrahedral faces. Such pseudo-octahedral crystals display deep striations along the edges.

Based on the experience of FP, the crystals range from colorless to deep yellow; larger ones are commonly color zoned with increasing saturation from core to rim. Facetable portions are present mainly near the rim of the largest crystals, although the best gems have been cut from smaller crystals (up to 1 cm).

MATERIALS AND METHODS

We examined 22 faceted samples (0.09–0.54 ct; figure 7) and nine crystal fragments (0.24–2.86 ct; see, e.g., figure 8) of natural-color rhodizite-londonite, as well as 24 faceted stones (0.06–2.42 ct) that were irradiated by WS (see, e.g., figure 9). These originally near-colorless samples were irradiated to greenish yellow or yellow in a Scintag XDS 2000 X-ray diffraction unit for 24 hours, at 35kV/15mA using $\text{CuK}\alpha$ radiation.

With the exception of specific gravity, standard gemological properties were obtained on all samples.

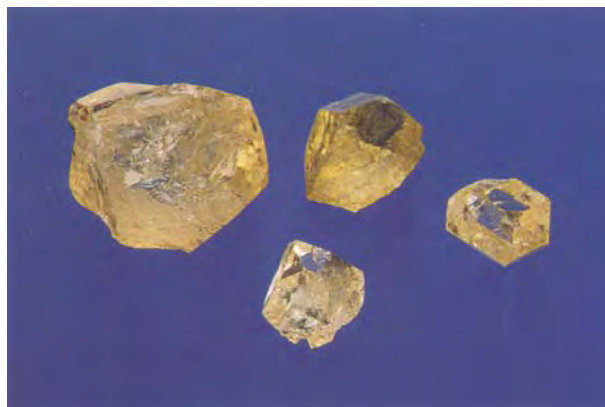
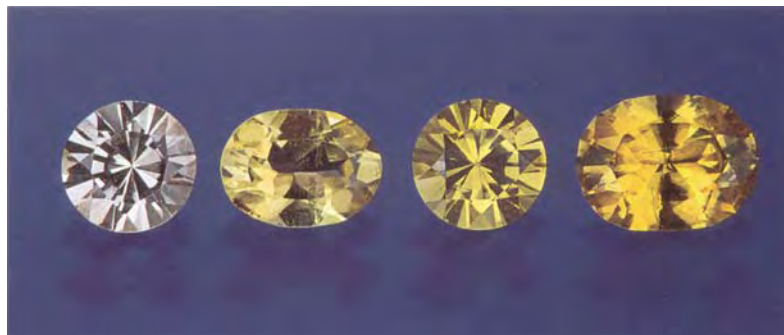

Figure 8. These four crystal fragments (up to 2.86 ct) of natural-color rhodizite-londonite were part of the sample base for this study. Photo by Maha Tannous.

A Duplex II refractometer with a near-sodium equivalent light source was used for refractive index readings. Specific gravity was determined by the hydrostatic method (for the 43 samples that weighed >0.20 ct), and a desk-model spectroscope was used to observe absorption spectra. Reaction to ultraviolet radiation was viewed with four-watt long- and short-wave UV lamps. Internal features were studied with a standard gemological microscope. Anomalous birefringence was observed with the microscope, and also with a polariscope.

Advanced testing was performed on selected faceted samples that were representative of the full color range shown by natural- and treated-color rhodizite-londonite. The three natural-color samples ranged from near colorless to a moderately saturated greenish yellow (0.27, 0.10, and 0.30 ct, respectively), and the two of treated color were a

Figure 9. The two stones on the left (0.28 and 0.30 ct) show the range of color seen in natural-color rhodizite-londonite, whereas the two stones on the right (0.28 and 0.39 ct) are representative of material that has been irradiated. Photo by Maha Tannous.



moderately saturated greenish yellow (0.28 ct) and yellow (0.39 ct). At GIA in Carlsbad, qualitative chemical analysis of four of these samples was performed with a Kevex Omicron energy-dispersive X-ray fluorescence (EDXRF) spectrometer, using a 200 second live time and two sets of analytical conditions to maximize detection of the elements Na through Fe. For two samples (0.30 and 0.39 ct), conditions were also optimized for the detection of rare-earth elements. The other two samples (0.10 and 0.28 ct) also were analyzed with a Tracor Xray Spectrace 5000 EDXRF spectrometer, using a 200 second live time with instrument parameters optimized for light elements and rare-earth elements.

UV-Vis-NIR absorption spectra of these four samples were obtained in the region 250–1000 nm with a Hitachi U4001 spectrophotometer. Fourier-transform infrared (FTIR) transmission spectrometry was performed on all five samples using a

Nicolet Magna 760 instrument. Spectra were collected from 6000 to 400 cm^{-1} at a resolution of 4 cm^{-1} . Raman spectra were obtained in the range of 2000–100 cm^{-1} with a Renishaw 2000 Ramascope laser Raman microspectrometer on the dodecahedral and tetrahedral faces of a natural-color crystal fragment, and on specific spots of the 0.10, 0.28, and 0.39 faceted samples that were known to be londonite or rhodizite from chemical analyses (see below). Mineral inclusions in selected samples (both faceted and rough) also were analyzed by Raman microspectrometry.

At the University of New Orleans, an Amray 1820 SEM, operated at 25 kV accelerating voltage, was used to generate backscattered electron images of eight faceted samples (including the five described above); these images were subsequently colorized to enhance visibility of the differences in atomic weight (and thus Cs content) across the table of each

TABLE 1. Properties of rhodizite-londonite from Antsongombato, Madagascar.^a

Composition	(K,Cs)Al ₄ Be ₄ (B,Be) ₁₂ O ₂₈ ; rhodizite is K-dominant and londonite is Cs-dominant
Color	Natural color: Near colorless to greenish yellow with moderate saturation Treated color (irradiated): Greenish yellow to yellow with moderate to strong saturation
Morphology	Isometric (cubic) system; crystals are equant with dominant dodecahedral {110} faces modified by deltoïd dodecahedral {221}, tristetrahedral {211}, and tetrahedral {111} faces and rare cubic {100} faces ^b
Weight of faceted stones	0.5–1 ct are typical, 1–2 ct are rare, and >2 ct are extremely rare
Refractive index	1.689–1.691; most were 1.690 1.693±0.001 (measured with Cargille oils) ^b
Specific gravity	3.34–3.42 3.34 (measured with a Berman balance) or 3.42 (calculated) ^b
Hardness	8 ^b
Luster	Vitreous ^b
Cleavage/fracture	No cleavage or parting; fracture is conchoidal ^b
UV fluorescence	
Short-wave (253.7 nm)	Very weak to moderate yellowish green
Long-wave (365 nm)	Inert to weak yellowish green
Internal features	Partially healed fractures with “fingerprint,” stringer-like, and “spiderweb” arrays of one- and two-phase inclusions; growth zoning (with a parallel planar, swirled, or roiled appearance) and associated anomalous birefringence; conchoidal fractures; feathers; needles and/or tubes; rare mineral inclusions (albite, columbite, pollucite, and chambersite; apatite, tourmaline, and quartz have been seen in rough gem material)
Optic character	Isotropic, commonly with anomalous birefringence in parallel planar, cross-hatched, patchy, and irregular, complex zones, or showing a subtle cloud-like appearance
Raman spectra	Main peaks at 470 and 430 cm^{-1} ; smaller peaks at 857, 803, 651, 544, and 294 cm^{-1}
UV-Vis-NIR spectra	Gradually increasing absorption below approximately 550 nm (greenish yellow and yellow samples) or 470 nm (near colorless sample), and cutoff below 300 nm; no features seen with the desk-model spectroscope
FTIR spectra	Complete absorption between approximately 3600 and 3150 cm^{-1} and below ~2400 cm^{-1} . Peaks at 5235 (with a shoulder at 5145), 4740, 4555, 4410, and 4130 cm^{-1} were present in all samples, and minor peaks at 4025 and 3910 cm^{-1} were recorded in some stones.
Fade testing in sunlight	Natural color: Slight fading after two weeks, noticeable fading after three weeks, and near colorless after one month Treated color (irradiated): Slight fading after one week, noticeable fading after nine days, and near colorless after three weeks

^a Arem (1987) reported that the dispersion of rhodizite is 0.018; this property was not determined for samples in this study.

^b Reported by Simmons et al. (2001).

stone. Quantitative chemical analyses of these samples were obtained using an ARL-SEMQ electron microprobe with 15 kV (for sodium) and 25 kV accelerating voltages, 15 nA beam current, and 3 µm beam diameter. Analyses were calibrated with natural mineral and synthetic compound standards, and a ZAF correction procedure was applied to the data. Generally five spots were analyzed on each sample. For samples showing discrete variations in Cs (as revealed in the backscattered electron images), analyses were obtained in areas representative of the highest and lowest Cs content. Where possible, surface-reaching inclusions were identified by electron microprobe analysis.

Fade-testing experiments were performed by placing one natural- and one treated-color sample (moderately saturated greenish yellow and yellow,

respectively) in a south-facing window in Carlsbad, California in November-December 2002. Samples of the same starting colors were kept in a darkened drawer for daily comparison to the test samples.

RESULTS

The results for general gemological properties, including internal features and spectra, are provided in table 1. The chemical and physical properties of selected samples are reported in table 2.

Visual Appearance. The natural-color samples (both rough and faceted) ranged from near colorless (one sample) to a slightly greenish yellow of moderate saturation, and the irradiated samples ranged from greenish yellow to yellow of moderate to strong saturation; both showed light tone (again, see figure 9).

TABLE 2. Chemical and physical properties of eight faceted rhodizite-londonite samples (natural and treated color) from Antsongombato, Madagascar.^a

Property	0.27 ct	0.18 ct	0.10 ct	0.30 ct		0.28 ct	0.32 ct	0.07 ct	0.39 ct	
Color	Near cls	Pale gY	Mod gY	Mod gY		Mod Y	Mod gY	Mod gY	Mod-str Y	
Color origin	Natural	Natural	Natural	Natural		Treated	Treated	Treated	Treated	
R.I.	1.690	1.690	1.69	1.691		1.690	1.690	1.69	1.690	
S.G.	3.36	nd	nd	3.39		3.39	3.34	nd	3.41	
Mineral	Rhodizite	Rhodizite	Londonite	Rhodizite	Londonite	Rhodizite	Londonite	Rhodizite	Rhodizite	Londonite
Oxides (wt.%)										
SiO ₂	bdl	bdl	bdl	bdl	bdl	bdl	bdl	bdl	0.04	bdl
B ₂ O ₃ calc	48.18	49.53	47.89	48.22	48.51	48.31	48.17	48.16	47.86	46.76
Al ₂ O ₃	25.93	26.92	25.73	25.87	25.99	26.00	25.97	25.88	25.70	25.25
BeO calc	15.73	16.17	15.64	15.75	15.84	15.78	15.73	15.73	15.64	15.27
Na ₂ O	0.08	0.14	0.10	0.16	0.23	0.04	0.02	0.17	0.09	bdl
K ₂ O	2.63	2.28	1.57	2.34	2.02	2.51	1.89	2.31	2.56	1.46
Rb ₂ O	1.27	1.14	1.63	2.00	2.20	1.27	1.78	1.24	1.71	1.59
Cs ₂ O	5.35	4.59	8.15	5.43	6.21	5.97	6.64	6.23	5.12	7.56
Total	99.17	100.77	100.71	99.77	101.00	99.88	100.20	99.72	98.72	97.89
Cations per 28 oxygens										
Si	bdl	bdl	bdl	bdl	bdl	bdl	bdl	bdl	0.006	bdl
B	11.000	11.000	11.000	11.000	11.000	11.000	11.000	11.000	10.994	11.000
Be	5.000	5.000	5.000	5.000	5.000	5.000	5.000	5.000	5.000	5.000
Al	4.042	4.082	4.035	4.030	4.024	4.042	4.050	4.037	4.033	4.056
Na	0.021	0.035	0.026	0.041	0.059	0.010	0.005	0.044	0.022	bdl
K	0.444	0.374	0.267	0.395	0.339	0.422	0.319	0.390	0.435	0.254
Rb	0.108	0.094	0.139	0.170	0.186	0.108	0.151	0.105	0.146	0.139
Cs	0.302	0.252	0.462	0.306	0.348	0.336	0.375	0.352	0.290	0.439
Sum of alkalis ^b	0.875	0.755	0.894	0.912	0.932	0.876	0.850	0.891	0.893	0.832

^aAbbreviations: bdl=below detection limits, cls=colorless, gY=greenish yellow, mod=moderate, nd=not determined, sl=slightly, str=strong, Y=yellow. Samples with two analyses showed areas with high and low Cs content in backscattered electron images, whereas those with only one analysis appeared to be more uniform in composition. All data by electron microprobe (average of five analyses, in general), with B and Be calculated by stoichiometry: B + Si = 11.000 apfu (atoms per formula unit) and Be = 5.000. Note that some columns may not add up exactly as shown, due to rounding. Detection limits (wt.%, calculated at 99% confidence levels) for Na₂O and SiO₂ were 0.018; not detected were CaO (0.008), Fe₂O₃ (0.006), MgO (0.011), MnO (0.018), and TiO₂ (0.015).

^bAlkalis are Na, K, Rb, and Cs. The apparent shortfall in this site, which should add up to 1.000, may be due to vacancies. However there is some uncertainty about this, since ZAF corrections for boron and beryllium could not be applied in the data reduction program.

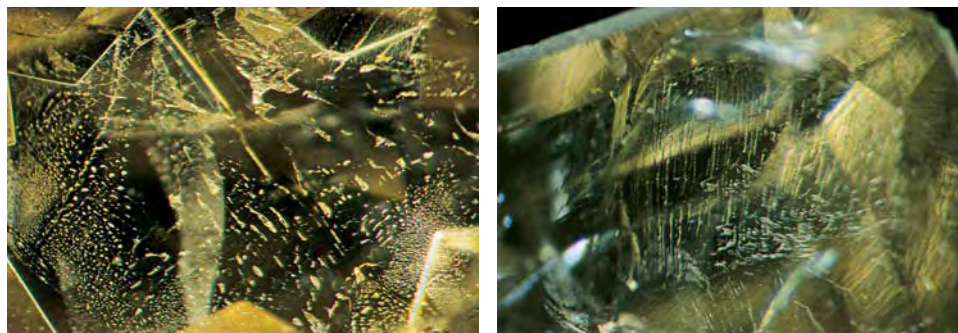

Figure 10. “Fingerprints” (left; magnified 25×) were the most common inclusion seen in the rhodizite-londonite. Partially healed fractures also took the form of subparallel stringers (right, magnified 15×) that resemble the step-like conchoidal fractures seen in some samples. Photomicrographs by John I. Koivula.

No color zoning was evident in any of the faceted or rough samples. The faceted stones were eye-clean to moderately included, and the rough ranged from semitransparent to transparent. Smooth crystal faces were present on all of the rough samples, which permitted the measurement of R.I. readings. The dominant dodecahedral {110} faces showed subtle striations, whereas smaller tetrahedral {111} modifying faces were smooth.

Physical Properties. R.I. values ranged from 1.689 to 1.691, but most samples (both natural- and treated-color) yielded 1.690. A few of the samples (particularly those of small size) showed nebulous R.I.’s that could only be determined as 1.69. Only three samples (all treated) yielded the 1.689 value, and the 1.691 value was obtained for seven of the treated and one of the natural-color stones. The eight samples that were chemically analyzed showed no relation between R.I. value and composition (all were 1.690 [or 1.69], except for one sample with zones of both rhodizite and londonite that yielded 1.691).

S.G. ranged from 3.34–3.42, although most values clustered around 3.37. There was no systematic

correlation between the S.G. values and composition (table 2), color, color origin, or size of the samples, or between rough and cut stones. All samples fluoresced yellowish green (very weak to moderate intensity) to short-wave UV radiation. Most were inert to long-wave UV, although a few (of both natural- and treated-color) fluoresced very weak to weak yellowish green. No features were seen with the desk-model spectroscope. The irradiated samples showed the same properties as the natural-color stones.

Internal Features. There were no differences in the internal features of the natural- and treated-color samples. When viewed with the microscope, the most common inclusions were partially healed fractures composed of one- and two-phase fluid-gas inclusions. They commonly resembled “fingerprints” (both wavy and flat planar), although planes of stringer-like fluid inclusions in subparallel or “spiderweb” arrangements were also seen in many of the samples (see, e.g., figure 10). The subparallel arrangement of these stringers mimicked the step-like conchoidal fractures noted in several of the samples. Small feathers were present in a few samples.

In two faceted stones, minute needles were seen along partially healed fractures, and another two samples contained tubes with flat cross-sections. Long, very thin needles (probably tubes) were also seen in a few of the stones (figure 11). Some appeared locally discontinuous, as if intermittently filled with fluid. In one crystal, these needles were abundant and oriented perpendicular to some crystal faces. Abundant needle-like inclusions with a similar appearance are locally present in other minerals from Antsongombato (i.e., quartz and tourmaline) from the same cavities in which the rhodizite-londonite occurs. In some cases, these microscopic tubes are filled with a fibrous white to pale brown mineral. Powder X-ray diffraction analysis of this mineral, as well as of the “needles” hosted in quartz, showed the presence of montmorillonite (unpublished data of FP).

Figure 11. Long, very thin needles (probably tubes) were seen in a few of the rhodizite-londonite samples. Photomicrograph by John I. Koivula; magnified 20×.

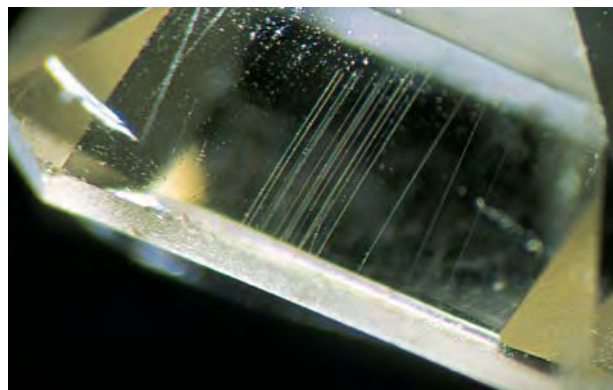

Figure 12. Mineral inclusions were seen in only two of the faceted rhodizite-londonites. One sample contained several colorless chambersite and tiny brownish red columbite inclusions (left). The chambersite inclusions were highly birefringent (right). Photomicrographs by John I. Koivula; magnified 25 \times .

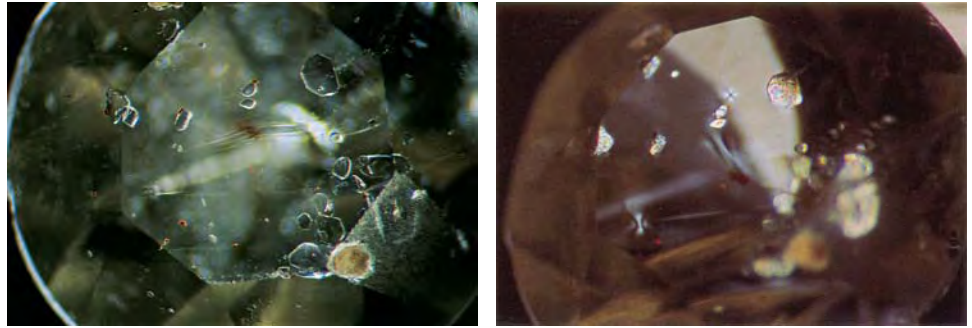
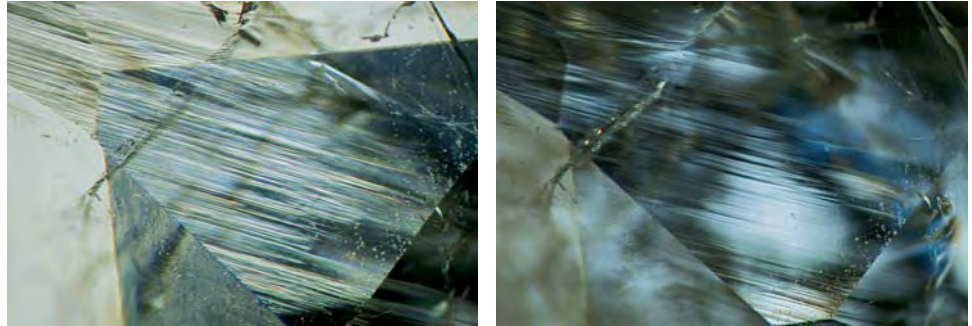

Figure 13. Strong planar growth patterns were visible with plane-polarized light in some of the rhodizite-londonites (left). When viewed with cross-polarized light, the growth patterns displayed anomalous birefringence (right). Photomicrographs by John I. Koivula; magnified 15 \times .



Mineral inclusions were rare. One faceted sample contained stout, euhedral, brownish red prisms identified as columbite by both Raman and electron-microprobe analyses (figure 12). Several colorless, subhedral birefringent inclusions (some surface-reaching) in this sample were identified as chambersite ($Mn_3B_7O_{13}Cl$) by a combination of Raman and electron-microprobe analyses. Three minute colorless inclusions just under the surface of a crystal fragment were identified as albite with Raman analysis. A minute, colorless inclusion that reached the surface of one faceted sample was confirmed as polucite by the electron microprobe. Other inclusions observed could not be identified due to their position and/or small size. These included a minute, colorless crystal with high relief and tiny colorless inclusions along a partially healed fracture. Blue apatite, pale pink tourmaline, and quartz have been noted in rough rhodizite-londonite from Antsongombato by some of the authors (FP, WBS, and AUF), but so far these inclusions have not been confirmed in faceted stones.

Growth patterns were seen in most samples, and ranged from subtle to very prominent. Isolated or multiple parallel planar features were most common (figure 13), although roiled, swirled, and angular patterns were seen in a few samples. One sample contained a series of triangular growth zones (figure 14). The growth zoning typically correlated to similar patterns of anomalous birefrin-

gence when viewed with cross-polarized light (again, see figure 13). This birefringence was obvious in all but four samples, and commonly formed striking patterns—parallel planar, cross-hatched, patchy, and irregular, complex zones—or more subtle clouds. The anomalous birefringence was directional in some samples, where it was visible only in specific orientations. With the polariscope, patchy, cloud-like, and planar patterns of anomalous birefringence were observed in most samples, but these appeared much less obvious than when viewed with the microscope.

Figure 14. Viewed through the table of this 0.28 ct rhodizite, a series of triangular growth zones are illuminated by light reflected from the pavilion facets. Photomicrograph by John I. Koivula; magnified 20 \times .

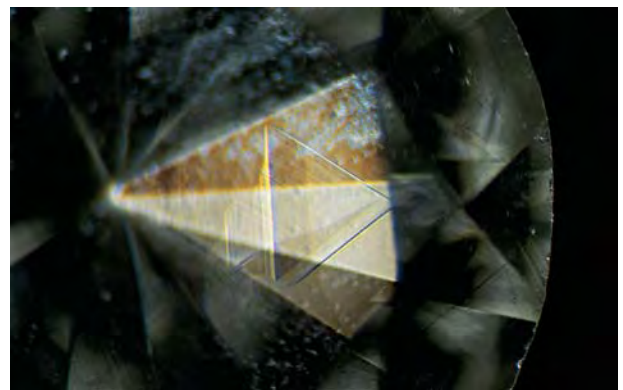

Chemical Composition. All eight of the Antsongombato samples analyzed by electron microprobe were remarkably similar in composition (see table 2), except for significant variations in cesium (4.59–8.15 wt.% Cs_2O) and minor differences in potassium (1.46–2.63 wt.% K_2O), rubidium (1.14–2.20 wt.% Rb_2O), and sodium (<0.02–0.23 wt.% Na_2O). Most samples consisted only of rhodizite or rhodizite + londonite (figure 15). To determine the particular species present, the cations for Cs, K, and Rb that were calculated from the electron microprobe data must be normalized to show their relative abundance in the alkali site. These data are conveniently evaluated by plotting the normalized values on a ternary diagram.

To evaluate the compositional heterogeneity of the samples before analysis, we viewed the table facet of each sample in backscattered electron (BSE) mode using the SEM. This imaging technique contrasts differences in average atomic number, since Cs is considerably heavier than K (and Rb), compositions corresponding to londonite show slightly lighter tones than those of rhodizite in standard

black-and-white BSE images. To improve contrast, the BSE images in figure 16 have been colorized. Striking heterogeneity was revealed in some samples, as elongate or patchy zones that are separated by sharp boundaries. One sample displayed a subtle, gradual chemical zonation within each zone (again, see figure 16). There was no correlation between color and composition in the samples analyzed.

None of the electron microprobe analyses revealed any Ca, Fe, Mg, Mn, or Ti. EDXRF spectrometry showed major Al, K, and Cs, as well as a small amount of Rb, as expected. Traces of Mn and Zn were detected by EDXRF in a 0.10 ct greenish yellow sample. No rare-earth elements were detected.

Raman Analysis. A Raman spectrum of a rhodizite-londonite crystal showed principal Raman peaks at 470 and 430 cm^{-1} , and smaller peaks at 857, 803, 651, 544, and 294 cm^{-1} . There were no Raman spectral features seen above 857 cm^{-1} . Analyses taken on dodecahedral and tetrahedral faces yielded identical spectra. The Raman spectra of three faceted samples of known composition also displayed the peaks at 470, 430, and 294 cm^{-1} ; however, the other peaks were often not present. No consistent differences in the Raman spectra were evident between the rhodizite and londonite areas in these samples.

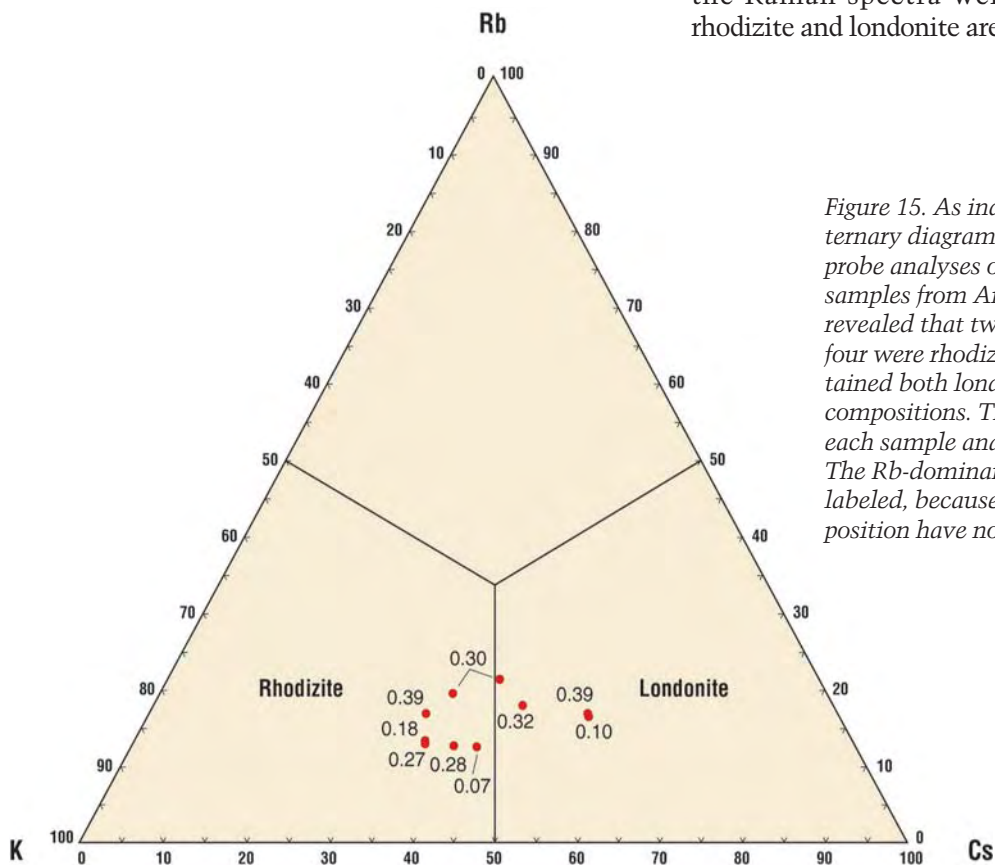

Figure 15. As indicated in this ternary diagram, electron-microprobe analyses of eight faceted samples from Antsongombato revealed that two were londonite, four were rhodizite, and two contained both londonite and rhodizite compositions. The carat weights for each sample analyzed are shown. The Rb-dominant field is not labeled, because stones of this composition have not been recorded.

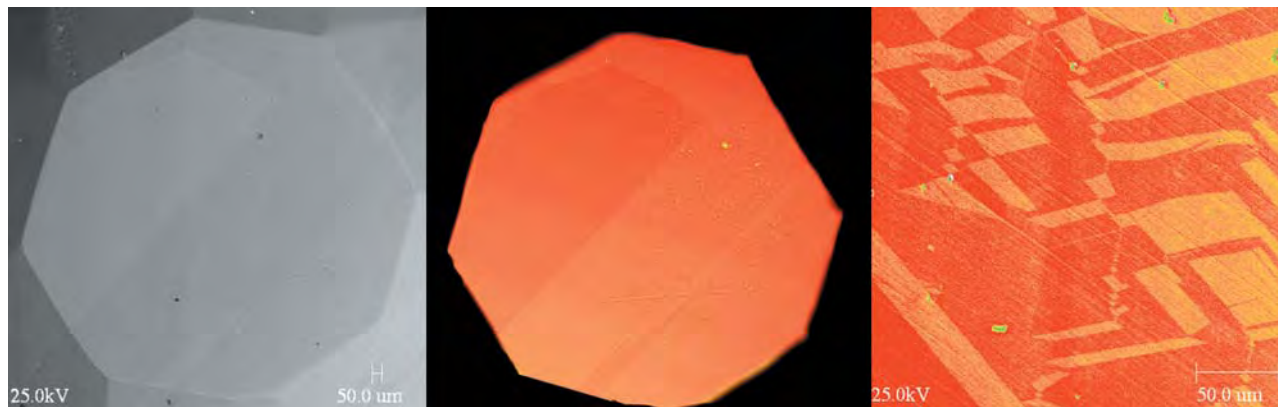

Figure 16. These backscattered electron (BSE) images of two rhodizite-londonite samples were generated with the electron microprobe to reveal compositional zoning (i.e., differences in overall atomic number). The standard BSE image on the left shows the table of a 0.07 ct round brilliant; lighter tones indicate heavier overall atomic weight (i.e., more Cs). Note the subtle tonal differences in diagonal zones, which are seen more easily in the colorized image in the center. The image in the center also shows subtle gradual zonation within each zone. The colorized BSE image on the right reveals the complex patchy compositional zoning on the table of a 0.30 ct sample. In both colorized images, yellow = rhodizite and orange = londonite. The minute yellow or green-blue spots correspond to pits on the surface of the samples.

UV-Vis-NIR Spectrometry. No sharp absorption features were recorded in any of the four samples analyzed. The near-colorless sample exhibited a slight, gradually increasing absorption below approximately 470 nm, and a cutoff below 300 nm. The absorption spectra for the natural- and treated-color greenish yellow and yellow stones were indistinguishable from one another, and showed a strong absorption band starting below about 550 nm, with a local maximum at approximately 355 nm. A cutoff below 300 nm was also present in the greenish yellow and yellow stones.

FTIR Spectrometry. All five samples showed complete absorption between approximately 3600 and 3150 cm^{-1} and below approximately 2400 cm^{-1} . Peaks at 5235 (with a shoulder at 5145), 4740, 4555, 4410, 4130, and 4025 cm^{-1} were present in all the spectra. The relative strength of the peaks at 4555 and 4410 cm^{-1} and at 4130 and 4025 cm^{-1} varied from sample to sample. Although the bulk composition of these samples was not determined quantitatively, surface variations in their Cs:K ratio were known from BSE images and electron microprobe analyses. Accordingly, a londonite sample showed a slightly stronger 4410 cm^{-1} peak compared to the 4555 cm^{-1} peak, and the opposite was shown by a rhodizite sample. Except for one sample (0.30 ct) of intermediate rhodizite-londonite composition, four samples displayed a minor peak at 3910 cm^{-1} . A peak at 4025 cm^{-1} was present in two samples of intermediate composition, and in the londonite sample. However, this peak was missing in the rhodizite sample.

Fade Testing. After one week of exposure to sunlight (on four sunny and three cloudy days), slight fading was seen in the treated-color sample; this sample was noticeably faded after nine days, and became near colorless after three weeks (figure 17). Slight fading of the natural-color sample was noticed after two weeks of exposure. This sample became noticeably faded after three weeks, and still retained some color after one month (again, see figure 17).

DISCUSSION

Our results indicate that rhodizite and londonite have overlapping gemological properties, and these mineral species cannot be separated without quantitative chemical analysis. FTIR spectroscopy may provide some clues, but further research is necessary. The physical properties obtained in this study are consistent with those of rhodizite and londonite that have been reported in the literature (e.g., Webster, 1994; Gaines et al., 1997; Simmons et al., 2001), although a slightly higher R.I. range was measured by Simmons et al. (2001). It was not possible to conclusively separate treated-color stones from those of natural color by any of the methods used in the current study. Although there were slight differences in their R.I. values (i.e., a greater variation shown by the treated-color stones), these were not distinct enough to aid in the identification of color origin.

According to our research, mineral inclusions are not common in faceted rhodizite-londonite. Those identified in this study are typical of the

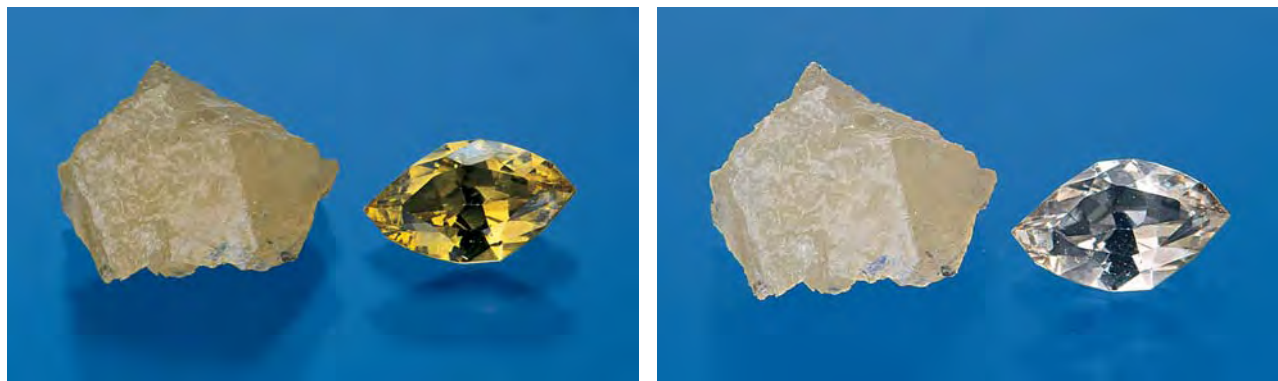

Figure 17. Before prolonged exposure to sunlight, these samples of rhodizite-londonite (a natural-color 1.44 ct rough, and an irradiated 0.29 ct faceted stone) were greenish yellow and yellow, as shown on the left. The treated-color stone became near colorless after three weeks, whereas the natural-color sample still retained some color after one month of exposure in a south-facing window (right image). Photos by Maha Tannous.

granitic pegmatite environment, with the exception of chambersite. This is the first time chambersite has been documented from any granitic pegmatite.

Early chemical analyses for Madagascar rhodizite were reported by both Lacroix (1910) and Duparc et al. (1911). For decades, there was considerable confusion over the chemical formula (see Frondel and Ito, 1965, as well as discussions by Pring et al., 1986, and Simmons et al., 2001). One reason for the confusion may be the difficulty of obtaining analyses of boron and beryllium.

The most Cs-enriched composition measured in our samples, 8.15 wt.% Cs_2O , approaches the highest value (8.37 wt.%) obtained thus far for londonite (from Antandromby, Madagascar; Simmons et al., 2001). However, the traces of Fe, Mn, and Ca in londonite from that locality were not detected in our samples from Antsongombato. As shown in figure 16, backscattered electron (BSE) images are effective for revealing chemical zoning in rhodizite-londonite from Antsongombato. Simmons et al. (2001) also documented Cs-enriched areas that showed feathery, oscillatory, and stringer-like shapes in rhodizite-londonite from other pegmatites found in central Madagascar.

The visible spectra do not yield any specific information on the origin of the yellow color. The color of rhodizite-londonite is most likely related to defects in the crystal structure, which appear to be light sensitive (Simmons et al. 2001). This was corroborated by the fade-testing experiments in this study. In addition, rhodizite-londonite collected from the mine dumps at Antsongombato was colorless on the side exposed to the sun, and a darker yellow on the unexposed bottom surfaces. Radiation-induced color centers may be responsible

for the color, as suggested by the change in hue from exposure to X-rays (Dr. G. Rossman, pers. comm., 2002). However, the fade testing performed for this study clearly showed that these color centers are somewhat less stable in the laboratory-irradiated stones.

The Raman spectra showed no consistent differences between rhodizite and londonite, regardless of whether the spectra were obtained from different portions of the same stone or from different stones.

Although the FTIR spectra showed some variations according to composition, their use for separating londonite from rhodizite remains inconclusive. This is due to the small number of samples examined, as well as to the lack of quantitative data on their bulk composition; such data would be required for comparison with the FTIR spectra since they were obtained with transmission geometry. However, our preliminary results suggest that further work on using FTIR spectroscopy for separating rhodizite and londonite could be worthwhile.

CONCLUSION

Londonite is a new gem mineral that occurs in a solid-solution series with rhodizite. The Antsongombato pegmatite in central Madagascar is the only known source of gem-quality rhodizite-londonite; more than 300 carats have been faceted since 1998. The gem rough was recovered during mining of the pegmatite for mineral specimens of yellow rhodizite-londonite and red tourmaline. Its attractive appearance and significant hardness (8 on the Mohs scale) make rhodizite-londonite a desirable gemstone for collectors who can find this scarce material in the gem trade. Note, though,

that both natural-color and irradiated rhodizite-londonite will fade on prolonged exposure to sunlight, so the stones should not be worn or displayed in lighting conditions that will promote fading.

Future production will be limited by the difficult

access and small size of the deposit. Since the pegmatite that has yielded all of the recently mined gem material appears exhausted, exploration for additional gem pegmatites in the Antsongombato area will be necessary before significant production can resume.

ABOUT THE AUTHORS

Mr. Laurs (blairs@gia.edu) is editor of *Gems & Gemology* at GIA in Carlsbad, California. Dr. Pezzotta is curator of mineralogy at the Museo Civico di Storia Naturale, Milan, Italy. Dr. Simmons is university research professor, and Mr. Falster is scientific research technologist, in the Department of Geology and Geophysics at the University of New Orleans, Louisiana. Mr. Muhlmeister is senior research associate at the GIA Gem Trade Laboratory in Carlsbad.

ACKNOWLEDGMENTS: The authors thank the staff of the Malagasy Geological Survey at the Ministry of Energy and Mines, Antananarivo, Madagascar, for providing permission to collect and export the gems used in this study. Pyramide Co. (Antananarivo) is thanked for loaning samples for this study. John Koivula of the GIA Gem Trade Laboratory in Carlsbad supplied photomicrographs. Dr. David London at the University of Oklahoma, Norman, is thanked for his comments on the text. Dr. George Rossman at the California Institute of Technology, Pasadena, provided insights on the possible origin of color.

REFERENCES

- Arem J.E. (1987) *Color Encyclopedia of Gemstones*, 2nd ed. Van Nostrand Reinhold, New York.
- Behier J. (1960) Contribution a la minéralogie de Madagascar. *Annales Géologiques de Madagascar*, No. 24, Imprimerie Officielle, Tananarive, p. 56.
- Boulanger J. (1958) Géologie et prospection de la région cotière du sud-est de Madagascar. *Travaux du Bureau Géologique de Madagascar*, No. 87.
- Collins A.S. (2000) The tectonic evolution of Madagascar: Its place in the East African Orogen. *Gondwana Research*, Gondwana Newsletter section, Vol. 3, No. 4, pp. 549–552.
- Demartin F., Diella V., Gramaccioli C.M., Pezzotta F. (2001) Schiavinatoite, (Nb,Ta)BO₆, the Nb analogue of behierite. *European Journal of Mineralogy*, Vol. 13, No. 1, pp. 159–165.
- Duparc L., Wunder M., Sabot R. (1910) Les minéraux des pegmatites des environs d'Antsirabé a Madagascar. *Mémoires de la Société de Physique et d'Histoire Naturelle de Genève*, Vol. 36, No. 3, pp. 283–407.
- Duparc L., Wunder M., Sabot R. (1911) Contribution a la connaissance des minéraux des pegmatites (Deuxième Note). *Bulletin de la Société Minéralogique de France*, Vol. 34, pp. 131–139.
- Emberger A. (1954) Etude géologique des feuilles Malaimbandy (506) et Midongy Ouest (507) au 1/200.000. *Travaux du Bureau Géologique de Madagascar*, No. 53, 121 pp.
- Falster A.U., Simmons W.B. (1989) Rhodizite formation in a Cs-Rb-B-Mn enriched pegmatite in Wisconsin. *Geological Society of America, Abstracts with Programs*, Vol. 21, No. 6, p. 119.
- Falster A.U., Pezzotta F., Simmons W.B., Webber K.L. (1999) Rhodizite from Madagascar: New localities and new chemical data. *Rocks & Minerals*, Vol. 74, No. 3, pp. 182–183.
- Fernandez A., Huber S., Schreurs G., Villa I., Rakotondrazafy M. (2001) Tectonic evolution of the Itremo region (central Madagascar) and implications for Gondwana assembly. *Gondwana Research*, Vol. 4, No. 2, pp. 165–168.
- Frondel C., Ito J. (1965) Composition of rhodizite. *Tschermaks Mineralogische und Petrographische Mitteilungen*, Vol. 10, No. 1–4, pp. 409–412.
- Gaines R.V., Skinner H.C.W., Foord E.E., Mason B., Rosenzweig A. (1997) *Dana's New Mineralogy*. John Wiley & Sons, New York.
- Lacroix A. (1910) Nouvelles observations sur les minéraux des pegmatites de Madagascar. *Bulletin de la Société Minéralogique de France*, Vol. 33, pp. 37–53.
- Lacroix A. (1922) *Mineralogie de Madagascar*, Vol. 1—Géologie, Minéralogie Descriptive. Augustine Challamel, Paris.
- Lefevre M., Thomas L. (1998) Les pegmatites de la vallée de la Sahatany, Madagascar. *Le Règne Minéral*, No. 19, pp. 15–28.
- Levinson A.A., Kane R.E., Gray M.E. (2001) Gem News: Recent observations at CISGEM. *Gems & Gemology*, Vol. 37, No. 4, pp. 332–333.
- Moore T. (2000) What's new in minerals—Tucson show 2000. *Mineralogical Record*, Vol. 31, No. 3, p. 280.
- Nizamoff J.W., Falster A.U., Pezzotta F., Simmons W.B., Hanson S.L., Webber K.L. (2000) Recent mining at the Antandrokombay pegmatite, Madagascar. *Rocks & Minerals*, Vol. 75, No. 4, pp. 255–256.
- Pezzotta F. (2001) Madagascar—A mineral and gemstone paradise. *extraLapis English*, No. 1, 97 pp.
- Pezzotta F., Franchi M. (1997) Mirolitic shallow depth pegmatites of the Betafo and Antsirabe areas, central Madagascar; genetic inferences. In R. Cox and L.D. Ashwal, Eds., *Proceedings of the UNESCO-IUGS-IGCP-348/368 International Field Workshop on Proterozoic Geology of Madagascar*, Antananarivo, August 16–30, Gondwana Research Group Miscellaneous Publication No. 5, p. 71.
- Pezzotta F., Falster A.U., Simmons W.B., Webber, K.L. (1998) New data on rhodizite from Madagascar. *17th General Meeting of the International Mineralogical Association, Abstracts & Programme*, August 9–14, Toronto, Canada, p. A153.
- Pring A., Din V.K., Jefferson D.A., Thomas J.M. (1986) The crystal chemistry of rhodizite: A re-examination. *Mineralogical Magazine*, Vol. 50, pp. 163–172.
- Rose G. (1834) Über den Rhodizit, eine neue Mineralgattung. *Annalen der Physik und Chemie*, Vol. 33, pp. 253–256.
- Rose G. (1836) Fernere Bemerkungen über den Rhodizit. *Annalen der Physik und Chemie*, Vol. 39, pp. 321–323.
- Simmons W.B., Pezzotta F., Falster A.U., Webber K.L. (2001) Londonite, a new mineral species: The Cs-dominant analogue of rhodizite from the Antandrokombay granitic pegmatite, Madagascar. *Canadian Mineralogist*, Vol. 39, pp. 747–755.
- Superchi M., Donini A., Gambini E., Muzzioli D. (2001) Recent observations at CISGEM—Rhodizite and other borates. *28th International Gemological Conference, Extended Abstracts*, Madrid, Spain, October 8–12, pp. 95–96.
- Webster R. (1994) *Gems—Their Sources, Descriptions and Identification*, 5th ed. Rev. by P.G. Read, Butterworth-Heinemann, London.



Editors

Thomas M. Moses, Ilene Reinitz,
Shane F. McClure, and Mary L. Johnson
GIA Gem Trade Laboratory

Contributing Editors

G. Robert Crowningshield
GIA Gem Trade Laboratory, East Coast
Karin N. Hurwit, John I. Koivula, and
Cheryl Y. Wentzell
GIA Gem Trade Laboratory, West Coast

“Piranha” AGATE

The West Coast laboratory recently examined a well-polished oval cabochon of attractively patterned agate. This 17.02 ct cabochon showed an unusual “eye” structure that was equally interesting in appearance on both the dome and base (figure 1), although it differed in color between the two sides. While most so-called eye agates display a single circular-to-semicircular multi-layered struc-

tural pattern around a central acicular inclusion, in this particular piece a well-matched pair of “eyes” had been more-or-less centered in the host during fashioning.

The agate from which this 31-mm-long cabochon was fashioned was recovered from the Piranha River in Ecuador, hence the name “Piranha” agate. Agates from this locality are commonly colored red-brown, orange, yellow, and black by iron compounds, with the patterns set off against a

background of translucent bluish white to white chalcedony. A display of these agates at the Tucson gem show in February 2002 showed similar colors and patterns. Raman analysis of the agate examined in our laboratory identified hematite and goethite as possible mineral colorants in both the black and orange areas, although the characteristic peaks were weak and poorly defined.

Another interesting feature of this agate was the way it was cut. Even though the cabochon was only 3.69 mm thick, the steep angle of the “eye” tube structure created an illusion of much greater depth (again, see figure 1). We do not know if this was intentional. None of the Piranha agates displayed in Tucson showed this pseudo-depth illusion.

While agates are one of the most common gem materials, beautifully patterned examples are unusual, and those suitable for jewelry applications are much rarer. Since no two patterns are ever the same, agates such as this one could be used by an imaginative designer to create a very distinctive piece of jewelry.

JIK and Maha Tannous

Figure 1. This colorful 31-mm-long “Piranha” agate from Ecuador shows an interesting double-eye pattern on both its dome (left) and base (right), although the “eyes” are dramatically different.

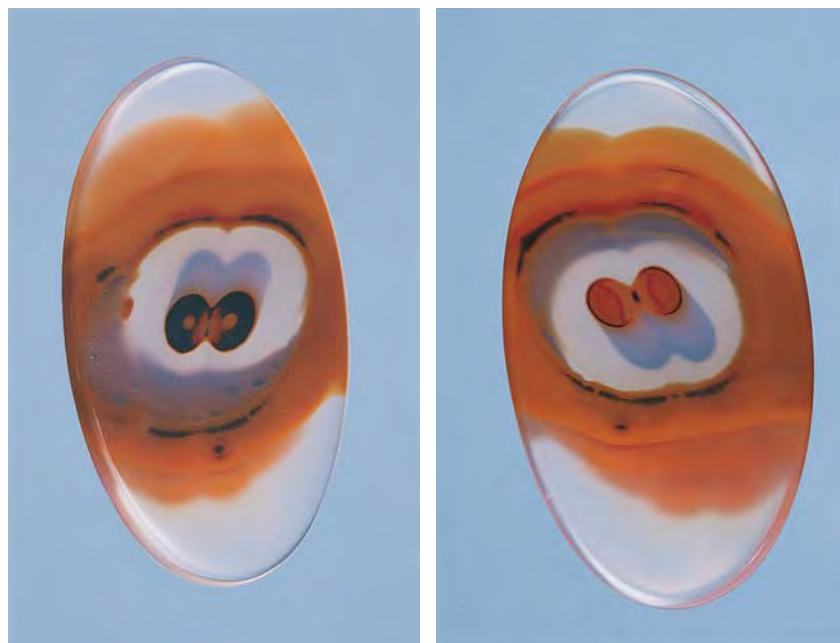

Editor's note: The initials at the end of each item identify the editor(s) or contributing editor(s) who provided that item. Full names are given for other GIA Gem Trade Laboratory contributors.

*Gems & Gemology, Vol. 38, No. 4, pp. 340–347
© 2002 Gemological Institute of America*

Surface-Treated AMBER

In the Winter 2000 issue of *Gems & Gemology* ("Gemstone enhancement and detection in the '90s," pp. 336–359), S. F. McClure and C. P. Smith reported on surface-enhanced amber in which a shallow dark brown surface layer is produced by controlled heating (figure 2). We have found that this treatment actually results in a wide range of colors, from brownish yellow to dark red-brown (see, e.g., figure 3, left). In numerous samples that have come through the lab, we have seen that the heating physically alters the surface of the amber and, thus, some of its gemological properties. In fact, the properties of some samples of this treated amber are closer to those reported for plastic than amber, which makes the identification a challenge.

We have noted that the refractive index of the surface-enhanced amber increases with the depth of color: that is, the darker the color of the surface layer, the higher the R.I. We have recorded a range of spot R.I.'s for this treated amber, with the highest being 1.60 for the darkest red-brown material. This is a significant deviation from the 1.54 R.I. characteristic of untreated amber.

We have also noticed an inverse relationship between the darkness of the enhanced color and the material's reaction to ultraviolet (UV) radiation: the darker the surface color, the lower the intensity of fluorescence. The surface enhancement tends to quench the strong chalky yellow and/or blue fluorescence characteristic of amber in long- and (weaker) short-wave UV (figure 3, right). The darkest treated material we have tested typically was inert or had only very weak brownish orange fluorescence to both wavelengths.

An amber bead necklace recently submitted to the West Coast laboratory for identification provided additional information. The beads showed a range of colors, including yellow, yellow-orange, orange-brown, and dark red-brown. The client was



Figure 2. The thin dark brown surface layer that originally covered this cabochon (39.25 × 25.70 × 9.05 mm) has been polished off the top, so it occurs only on the back (see inset). This allowed the carver to cut flowers into the pale yellow body of the piece so they would stand out against the remaining dark brown surface layer that was created by controlled heating.

particularly interested in the darkest beads, since their properties were quite different from those that have been reported for amber. We noted in all but the yellow beads that the varying depths of color correlated to the variations in refractive index and

fluorescence that we had noted in other samples of treated amber, as described above.

Since the properties at the surface of this treated material are not consistent with those reported for amber, how do we identify it? Specific gravity

Figure 3. Some surface-enhanced amber appears orangy brown in standard illumination, as evident in this 25-mm-diameter hololith. With exposure to long-wave UV radiation (right), a weak brownish orange fluorescence, atypical of amber, is seen on most of the hololith; the strong chalky blue fluorescence commonly seen in amber is visible only in the small area where the surface layer has been polished off. The R.I. of the dark surface was 1.59, and that of the underlying yellow material was 1.54.

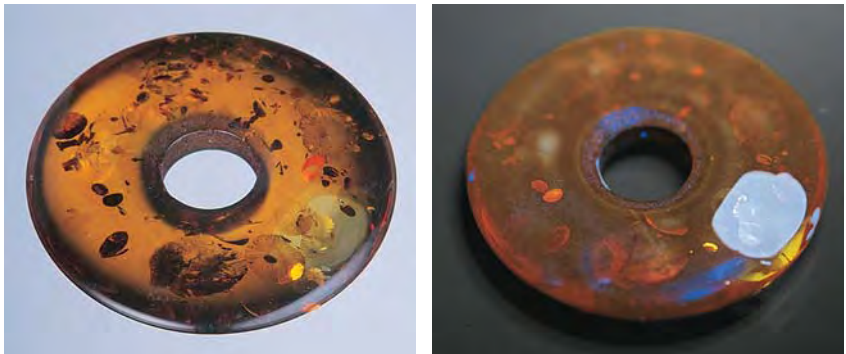

is useful for loose samples, as we have observed no difference in the S.G. recorded for loose treated and untreated material. In both cases it is around 1.08, which is significantly lower than the S.G. of most plastics used as amber imitations. Another consistent property is amber's odor when touched with a thermal reaction tester. Treated or untreated, amber will emit a resinous odor, as opposed to the typical acrid odor of most plastics. Nevertheless, this identification can be especially tricky when the material is mounted in jewelry.

To learn more about this surface-treated amber, we acquired five samples for research purposes and polished through their dark surface layers. In all cases, this layer was extremely thin, and the underlying material was very pale yellow—much paler than the typical color of untreated amber. Changes in R.I. and fluorescence occurred only at the darker, heat-induced surface; the underlying amber retained the usual properties. Removal of the surface layer is obviously destructive and therefore not feasible in most cases. However, the difference in fluorescence may sometimes be viewed at small chips around drill holes or on girdle edges. Observation of this difference between surface and internal fluorescence can be a useful aid to identification, since plastic imitations would not react in this way.

We previously reported on amber with similar surface-related coloration that faded on exposure to light (see Summer 1993 Lab Notes, pp. 122–123). That report did not note any variances in refractive index, although it did mention an unusual orange fluorescence. We did not test the samples mentioned above for color stability.

The conclusion on GIA Gem Trade Laboratory reports for this material is accompanied by the following comment: "The color of this amber is primarily confined to a shallow surface layer that has been artificially induced by heat treatment. Such color may fade."

Elizabeth Quinn and SFM

Unusual CERAMIC Gem Simulant

Laboratory gemology is not always concerned with the identification of treatments and natural-versus-synthetic determinations. Occasionally, we have the distinct privilege of examining items that are downright baffling. A good example from the recent past was an iridescent piece of hard plastic that its owner believed was an opal. The micro- and macro-structure, texture on the broken surface, and curvature of this specimen made us suspect that it was a fragment from a bowling ball. Recently, the West Coast laboratory examined an unpolished hemispherical "cabochon" of dense white material that a pearl distributor had submitted for identification.

This hemisphere was opaque (figure 4) with a sawn back; closer examination revealed two parallel mold marks extending diagonally across the dome. It weighed 125.39 ct and measured approximately 20 mm in diameter. We could not take a refractive index reading because of the lack of a polished surface.

No visible spectrum was observed in surface-reflected light through a prism spectroscope. When exposed to long-wave UV radiation, the item showed a moderate, somewhat mottled brownish red luminescence, while the reaction to short-wave UV was pink rather than red and much

Figure 4. Represented as a pearl, this 20 mm opaque white "cabochon" was identified as a molded form of ceramic.



weaker. Hydrostatic specific gravity was calculated, from an average of three readings, as 3.57.

With magnification, the two parallel mold seams were clearly visible, as were saw marks on the base. In addition, small, dull, conchoidal fractures were evident around the edge of the base, and the material itself revealed a very fine granular texture, reminiscent of a ceramic, such as porcelain that would be used in various common bathroom fixtures. This was clearly a manufactured product and not a pearl.

Since we are not often called on to identify ceramic materials, we performed energy-dispersive X-ray fluorescence analysis to complete the examination. This showed the presence of aluminum, barium, calcium, gallium, iron, strontium, and titanium, with Al, Ga, and Sr being dominant. Laser Raman microspectrometry showed a broad curve, as would be expected for an amorphous substance such as a glass, but no sharp peaks.

JIK, KNH, and Sam Muhlmeister

CORUNDUM

More Bulk Diffusion—Rubies and Orange Sapphire

In the Fall 2002 Lab Notes (pp. 254–255), we described an orangy yellow sapphire that had been subjected to bulk (also called lattice) diffusion with beryllium. *Bulk or lattice diffusion* is defined as "a diffusion process which takes place through the bulk lattice of the crystal and excludes such mechanisms as short circuit diffusion along dislocations, grain boundary diffusion, and surface diffusion" (Kizilyalli et al., "Definitions of terms for diffusion in the solid state," *Pure and Applied Chemistry*, Vol. 71, No. 7, 1999, pp. 1307–1325). In terms of this corundum treatment, the orange component of the color is a result of beryllium diffusion into the bulk lattice of the crystal, which creates a Be concentration gradient, as opposed to Be diffusion within grain boundaries or on the surface. We continue to investigate the range

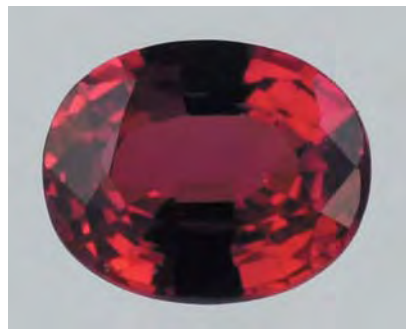

Figure 5. The color in this 0.63 ct oval mixed-cut ruby was produced by bulk diffusion treatment with beryllium.

of corundum that has been subjected to this diffusion treatment and the color changes that result.

Figure 5 shows an attractive oval mixed-cut ruby with clear evidence of heat treatment that was submitted to the East Coast laboratory for routine testing. Although we were not able to identify the exact nature of the inclusions, the stress fractures emanating from them—as well as the partial healing of these and other fractures—indicated that the heating conditions were extreme (see figure 6). Examination of the stone while it was immersed in methylene iodide revealed what appeared to be a very shallow orange rim or other form of color concentration near the ends of the sample, but we could not conclusively determine if this was the case. Immersion observations also revealed a few small areas on the surface that showed differences in luster, which indicated that a glass-like residue had filled shallow cavities during the heating process.

Suspicious that this ruby might have been subjected to a diffusion treatment comparable to that more commonly seen in orange-pink and yellow sapphires, we performed chemical analysis using secondary ion mass spectrometry (SIMS). As previously described (see, e.g., Spring 2002 Gem News International, pp. 86–90), this method allows for the detection of trace amounts of light elements to

the level of parts per million (ppm). The SIMS analysis confirmed our initial concern: The concentration of Be at the surface of this stone was about 11 ppm. Based on our previous analyses, this is much higher than the Be concentrations in either natural, untreated sapphires (typically less than 1 ppm) or those heated by traditional methods, and it is within the concentration range that would produce an orange rim and alter the intrinsic color of the ruby. We are not certain what the starting material looked like, but we suspect that it was purplish and much darker.

About a week after the previous stone was submitted for testing, we received a second natural ruby of approximately the same color. As with the previous stone, this ruby displayed evidence of heating. In this case, the evidence consisted of dust-like rutile surrounded by color concentrations indicative of internal diffusion, which had been dissolved, and also healed “fingerprints.” Exami-

Figure 6. Stress fractures and partially healed “halos” surrounding included crystals in the ruby shown in figure 5 provide clear evidence that the stone was subjected to extremely high temperatures. Magnified 63 \times .

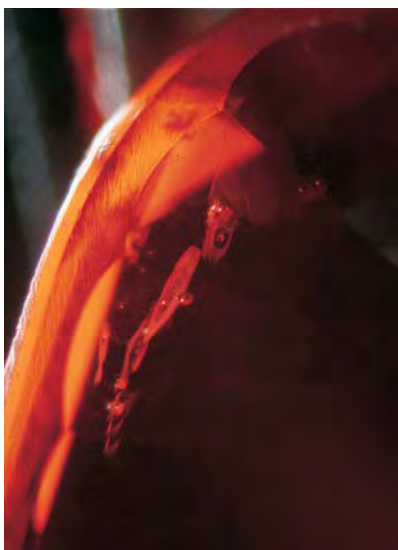

Figure 7. This 2.78 ct oval mixed-cut ruby appears to have been treated by the same method as the ruby shown in figure 5.

nation in immersion clearly revealed a rim of orange color that followed the facet outline. Such color zoning proved that this stone also had been subjected to lattice diffusion treatment. The ruby illustrated in figure 7 was treated in a similar manner. These examples of orangy red ruby are typical of what we have begun to associate with this type of Be diffusion.

Most recently, Yoshiko Doi, president of GIA Japan, sent us an orange sapphire that was clearly heated and in fact had not been repolished after its removal from the crucible (figure 8). Microscopic examination showed the corroded surface one would expect for a heated sapphire, but it also revealed numerous areas of new crystal growth. Such recrystallization is often seen in rubies and sapphires that are subjected to high temperatures with fluxing agents (see, e.g., Fall 2002 Lab Notes, pp. 255–256), but we were surprised at the extent of the new crystal growth. Although most of the new crystals were similar in habit to tabular corundum (figure 9), we turned to chemical analysis to positively identify them.

One of the contributors (MH) collaborated with researchers at the Laboratory for Mineral Deposits Research at the University of Maryland, where the stone was examined with a JEOL JXA-8900R electron microprobe with imaging capabilities (figure 10). Chemical analysis of the



Figure 8. The unpolished surface of this 0.48 ct orange sapphire displayed obvious signs of heat treatment.



Figure 9. Microscopic examination (at 45×) of the sapphire in figure 8 revealed tabular crystal regrowth after extreme heating.

tabular regrown crystals by energy-dispersive spectrometry (EDS) indicated that they were corundum. It appears that the extremely high temperatures being used, combined with fluxes, essentially dissolve part of the surface of the corundum; this serves as a feed source for new corundum growth that develops during cooling. SIMS analysis of the unpolished surface revealed a Be concentration of 99 ppm, far higher than that seen in repolished sapphires that were apparently treated

by the same method. This high Be concentration confirms that Be was diffused into the sample during the annealing process.

Thus far, we have confirmed Be lattice diffusion as the cause of color in pinkish orange, orange, orangy red, and yellow sapphires, as well as in ruby. This treatment is indeed being used to produce a very wide range of colors in corundum.

TMM, Matthew Hall,
and Wuyi Wang

Figure 10. These secondary electron (left) and backscattered electron (right) images of the treated sapphire in figure 8 clearly show the tabular habit of the newly grown crystals. EDS chemical analysis indicated that these crystals are corundum. The bright spots in the image on the right are remnants of silver powder used for SIMS analysis. The scale bar is 100 μm .

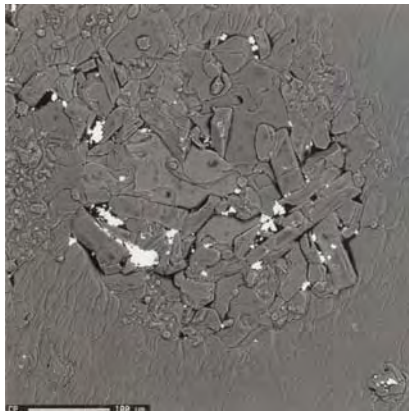
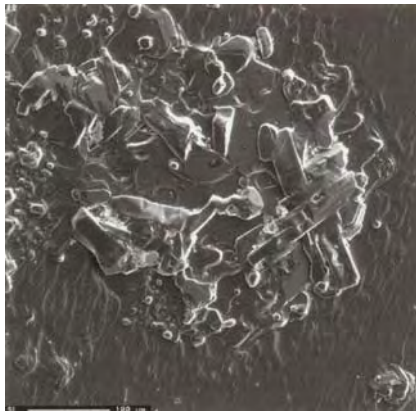

DIAMOND

With Internal Inscriptions

Diamond inscriptions are typically created by lasering characters on the girdle surface. Recently, though, the East Coast lab has seen three inscriptions that were totally within the interior of the diamond. Two different methods appear to be responsible.

The first two diamonds had characteristics similar to those caused by internal laser drilling, as documented by S. McClure et al. ("A new lasering technique for diamond," Summer 2000 *Gems & Gemology*, pp. 138–146). It is possible that the technology described in that article was a collateral effect of early experiments to place internal inscriptions in diamonds. The inscription in figure 11 was placed on an internal fracture. The black letters "NE" are clearly visible. The other small internal fractures in the same area have black lines extending along their length. These black lines are typical of those associated with fractures created during the internal laser drilling process. It appears that the black lines on this fracture were controlled to create the letters.

Figure 12 shows a similar internal inscription. In this case, the number "2" is inscribed on a small fracture present in this 2.14 ct oval brilliant.

The inscription "31107345" in the third stone, a 1.01 ct rectangular modified brilliant, was also totally internal, but had a much different appearance (figure 13). We believe ion implantation is responsible for this second type of inscription, because it is not associated with any inclusions. This is a method (also known as doping) whereby ions (charged atoms) are introduced into a solid through their high kinetic energy (see R. Kalish and S. Prawer, "Ion implantation of diamond and diamond films," in M. A. Prelas, G. Popovici, and L. K. Bigelow, Eds., *Handbook of Industrial Diamonds and Films*, Marcel Dekker Inc., New York, 1998, pp. 945–982). By bombarding the diamond with atoms of either argon or boron, one can make "marks" inside the stone.

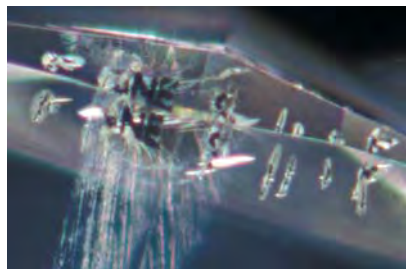

Figure 11. This 0.57 ct diamond contains a series of internal fractures with black lines, typical of those created by a recently documented internal laser drilling process. One of these fractures, located just behind the prominent, surface-reaching feather, has the letters "NE" inscribed on it. Magnified 63x.

The marks are actually slight deformations in the crystal lattice that scatter light, and thus they tend to show up as thin white lines. Note that the depth of the inscription is uniform, and that it is suspended a uniform distance below the surface (i.e., a few tenths of a millimeter). This can be achieved by controlling the energy of a beam of ions of a particular size.

It is possible that these three internal inscriptions were done for trial purposes, since we have seen only a limited number of them to date. However, given the apparent high degree of control in the internal lasering process, we believe such inscriptions may become more common. Internal inscriptions would have one benefit over the typical surface inscription in that they would be extremely difficult to remove. However, creating fractures in a diamond or printing letters below the surface would amount to adding inclusions to a stone, which could have a direct effect on the clarity grade.

Joshua Sheby and Vincent Cracco

Two Large GLASS Imitation Jade Carvings

It has been said that imitation is the sincerest form of flattery, and given

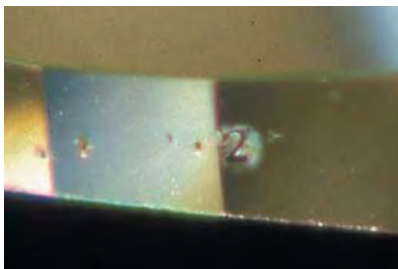

Figure 12. This internal fracture has the number "2" inscribed on it. Magnified 63x.

the high value of jade, it is not surprising that it is so frequently imitated. Over the years, many jade imitations have been reported in both Lab Notes (see, e.g., Fall 1983, pp. 173–174; Summer 1996, p. 123; Summer 2001, p. 133) and Gem News (Winter 1990, p. 309; Summer 1995, p. 137). Most of these items were small—loose cabochons or carvings set in jewelry.

This past fall, however, one client sent the East Coast laboratory two large carvings for identification: one approximately 35.00 × 14.00 × 9.00 cm (see figure 14), and the other approximately 50.00 × 16.00 × 8.00 cm. Each was packed in a padded box that was ornately decorated. The client told us the two carvings recently had been purchased together in Asia as jadeite jade for a large amount of money.

Both items were a semi-translucent to opaque very light grayish green, and both appeared to be carved from the same material (the results of their testing were identical). The polish was poor, and the refractive indices were in the low 1.50s. The objects fluoresced very weak yellow to long-wave UV radiation, and weak to medium yellow to short-wave UV. Close examination revealed no crystalline structure and a few tiny conchoidal chipped areas that displayed vitreous luster. Horizontal illumination with a pinpoint fiberoptic light showed small but eye-visible round and elongated gas bubbles throughout both items, along with the swirled flow lines that are commonly seen in glass. This narrowed the identification to glass or plastic. Testing



Figure 13. A mirror reflection is proof that this inscription in a 1.01 ct diamond is totally internal. Ion implantation is thought to be responsible for the inscription. Magnified 63x.

with hardness points on inconspicuous areas demonstrated that the material had a Mohs hardness greater than 5, thereby eliminating plastic. Both were

Figure 14. This large figurine (35 × 14 × 9 cm), purchased in Asia as jadeite jade, was identified as manufactured glass.



identified as “Glass, a manufactured product.”

In this era of new treatments and ever-increasing synthetics, these carved items should serve as a reminder that some of the oldest and least expensive imitations are still being offered, and gemologists should not dismiss such possibilities because of the apparent age or simplicity of the piece.

Wendi M. Mayerson and KNH

JADEITE

Bleached, Impregnated, and Dyed, with Unusual Inclusions

A translucent, variegated green bangle bracelet was recently submitted to the East Coast lab for identification. Standard gemological testing proved the bangle to be dyed jadeite jade: an R.I. of 1.66, a 437 nm line and 650 nm “dye-band” visible with the desk-model spectroscope, an aggregate structure, and color concentrations along grain boundaries. Reflected light in combination with magnification revealed an unusual surface texture, the result of preferential erosion of certain grains during the “bleaching” process commonly associated with “B jade” (see, e.g., Winter 1994 Lab Notes, pp. 266–267). The randomly oriented interlocking grains of jadeite become visible as the acid-soluble

Figure 15. With reflected light and magnification (here, 50×), the differences in luster between the jadeite grains and the filled channels and small cavities surrounding them can be seen.



Figure 17. Several of the “golden” yellow cultured pearls in this graduated strand (12–15 mm) proved to be enhanced.

minerals that lay between them are removed, creating narrow outlines around the grains and small cavities between them. These channels and cavities are then filled with either a polymer or a wax. Reflected light and magnification also revealed the differences in luster between the jadeite grains and the filled channels and small cavities (figure 15), which indicates that this bracelet was indeed impregnated. The fact that the bangle fluoresced a medium mottled greenish yellow to long-wave UV radiation, and a very weak mottled yellow to short-

Figure 16. The dark violetish blue inclusions seen “floating” in the filler are visible indications that this jadeite bangle bracelet has been treated. Here, they appear black due to the lighting conditions. Magnified 300×.

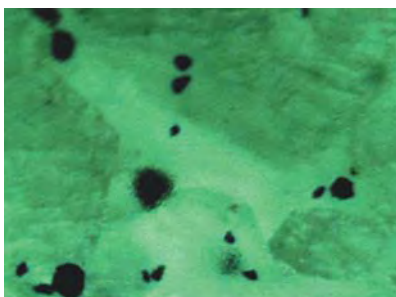

wave UV, further indicated impregnation (see Spring 1995 Lab Notes, p. 55).

All jadeite submitted to the GIA Gem Trade Laboratory is checked for impregnation via infrared spectroscopy. Such testing confirmed that this bracelet was impregnated, and it was officially identified as “dyed and impregnated jadeite.” Although infrared spectroscopy is currently the most efficient method to prove impregnation (see E. Fritsch et al., “Identification of bleached and polymer-impregnated jadeite,” Fall 1992 *Gems & Gemology*, pp. 176–187), its use is generally restricted to laboratories or large companies due to the high cost of the instrument. Therefore, when visible indications are present, they are extremely helpful for the practicing gemologist.

Such was the case with our bangle bracelet. Not only did the visual clues mentioned above serve as useful indicators of treatment, but when the bangle was viewed in combined transmitted and reflected light with the added strength of a fiber-optic light, several dark inclusions could also be seen “floating” in a lower-luster (filled) area (figure 16). These were reminiscent of the tiny green spherules and gas bubbles discovered in the polymer of a bangle bracelet examined earlier (Spring 1999 Lab Notes, pp. 44–45). What

made these new inclusions so unusual was the fact that, although the bracelet was dyed green, these inclusions were dark violetish blue and found in only two small areas of the filler. Even though we could not determine their identity, they are another good visible indication that the bracelet was treated.

*Siau Fung Yeung and
Wendi M. Mayerson*

CULTURED PEARLS

With Treated Yellow Color

For the past several months, the East and West Coast laboratories have seen an increasing number of strands of "golden" yellow pearls submitted for identification. These graduated strands all featured fairly large (12–15 mm) yellow pearls that were well matched in color and luster. X-radiography, reaction to long-wave UV radiation, and visual inspection readily identified the majority as cultured pearls of natural color. However, a few cultured pearls in one necklace (figure 17) had characteristics that ultimately proved their color was enhanced.

Routine visual inspection revealed that some of the cultured pearls had peculiar opaque white non-nacreous areas on the surface. A few of these growth features actually represented depressions in the nacre, some with a

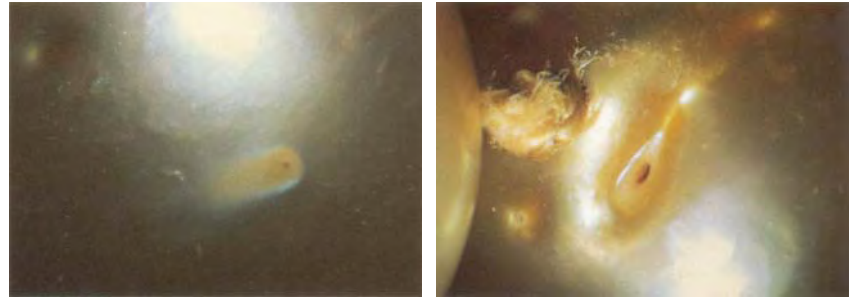

Figure 18. The red spots in these different types of growth marks seen on "golden" cultured pearls indicate treated color. Although here, because of the lighting conditions used, the growth marks appear yellow, they were actually white. Magnified 15x.

central opening. While examining these cultured pearls with long-wave UV to determine the origin of color, we noticed that the greater part of the surface area fluoresced yellow-green, but the nonnacreous areas fluoresced yellowish white and their centers were inert. Examination of these areas with strong overhead illumination at 15x magnification revealed isolated bright red spots (see figure 18). One such growth mark also showed a small opening in the nacre that had a bright red rim. Since this type of spotty red coloration does not occur naturally in yellow pearls, we believe it must have been the result of treatment.

This is not the first time we have seen such evidence of color enhance-

ment in yellow cultured pearls. This contributor recalls having noticed similar features in known treated yellow cultured pearls at least five years ago, just as "golden" pearls were gaining in popularity. The presence of such characteristics allows the practicing gemologist to conclusively identify treated color in yellow cultured pearls. *KNH*

PHOTO CREDITS

Maha Tannous—figures 1, 2, 3, 4, and 17;
Elizabeth Schrader—figures 5, 7, and 14;
Vincent Cracco—figures 6, 8, 9, 11, 12, and 13;
Wendi Mayerson—figures 15 and 16;
John I. Koivula—figure 18.

Vote now and Win!

a FREE laminated gem treatments chart PLUS a three-year subscription to

GEMS & GEMOLOGY

THE

DR. EDWARD J. GÜBELIN

MOST VALUABLE ARTICLE AWARD

Simply tell us which three 2002 articles you found most valuable, and you could win a FREE laminated gem treatments chart PLUS a three-year subscription to GEMS & GEMOLOGY. Mark the articles in order of preference on the ballot card in this issue. Then mail the card to arrive no later than **March 24, 2003** and it will be entered in a drawing for the grand prize—

See card between pages 368 & 369 for ballot

SEND IN YOUR BALLOT TODAY!



EDITOR

Brendan M. Laurs (blaurs@gia.edu)

CONTRIBUTING EDITORS

Emmanuel Fritsch, *IMN, University of Nantes, France* (fritsch@cnsr-imn.fr)

Henry A. Hänni, *SSEF, Basel, Switzerland* (gemlab@ssef.ch)

Kenneth V. G. Scarratt, *AGTA Gemological Testing Center, New York* (kscarratt@email.msn.com)

Karl Schmetzer, *Petershausen, Germany* (schmetzerkarl@hotmail.com)

James E. Shigley, *GIA Research, Carlsbad, California* (jshigley@gia.edu)

Christopher P. Smith, *Gübelin Gem Lab Ltd., Lucerne, Switzerland* (cpsggl2@hotmail.com)

DIAMONDS

Kimberley Process ratified. After more than two years of legal and diplomatic maneuvering, 53 nations approved the Kimberley Process at a meeting in Interlaken, Switzerland, on November 5, 2002. The Kimberley Process is a system of controls on diamond imports and exports that is designed to reduce the trade in illicit and conflict diamonds. Forty-eight nations, including all major diamond producers and manufacturing centers, implemented the controls January 1, 2003. Five other nations that participated in the process, including the Czech Republic, Japan, and Sri Lanka, will implement controls later this year.

Under the Kimberley Process, which was developed by the diamond industry and backed by the United Nations, all exports of rough diamonds must be sealed in tamper-proof containers and certified by the local government that they come from legitimate sources. The paperwork must accompany the diamonds all the way through the manufacturing and sales (wholesale and retail) chain. Participating countries will no longer permit imports of diamonds that do not carry such paperwork. For more information on the details of the process, visit www.worlddiamondcouncil.com.

In the United States, the Diamond Manufacturers and Importers Association of America, in cooperation with U.S. government agencies and shipping companies, has established the Rough Diamond Export Mechanism for monitoring the flow of all diamonds exported from the country. European Union member countries and Canada have set up similar organizations.

The Jewelers of America has also advised its 11,000 member retailers that each time a diamond changes hands, the seller must attest to its legitimacy by means of a warranty stating the stone "has been purchased from sources not involved in funding conflict and in compliance

with United Nations resolutions." The JA also urged members to require all of their diamond suppliers to offer this warranty on every invoice, and to retain the paperwork for five years.

De Beers's director of public and corporate affairs, Rory More O'Ferrall, told sightholders at a December 2002 meeting that, even though the conflicts have ended in Angola and Sierra Leone (the original targets of the Kimberley Process), the industry must remain committed to ending trade in conflict and illicit diamonds. "First there is still a civil war and appalling human suffering in the Democratic Republic of the Congo. Second, we must accept that many governments and civil society groups are looking beyond conflicts to address the possibility that illicit diamonds are used to facilitate money laundering and, more significantly, terrorism. While no evidence of this whatsoever has been produced, the very fact that diamonds could be misused in this way is enough to ensure that governments insist on a better-regulated industry."

*Russell Shor (russell.shor@gia.edu)
GIA, Carlsbad*

Editor's note: Bylines are provided for contributing editors and outside contributors; items without bylines were prepared by the section editor or other G&G staff. All contributions should be sent to Brendan Laurs at blaurs@gia.edu (e-mail), 760-603-4595 (fax), or GIA, 5345 Armada Drive, Carlsbad, CA 92008.

GEMS & GEMOLOGY, Vol. 38, No. 4, pp. 348-369
© 2002 Gemological Institute of America

COLORED STONES AND ORGANIC MATERIALS

Alexandrite from Mananjary, Madagascar. Emerald production from the Mananjary region of eastern Madagascar started in the early 1960s. Numerous emerald finds led to mining activities that continue on a small scale (see D. Schwarz and J. Kanis, "Emeralds from Africa," in G. Giuliani et al., Eds., *extraLapis English No. 2: Emeralds of the World*, 2002, pp. 52–59).

More recently, small quantities of alexandrite have been mined from the Mananjary area. The alexandrite deposit has been known for about 4 years, and is located south of Mananjary, between Mananjary and Farafangana (F. Pezzotta, pers. comm., 2002). According to A. Leuenerger (pers. comm., 2002), several hundred grams of rough material (though little of gem quality) were available from the area in 1999.

This contributor recently obtained one loose twinned crystal and one hand specimen of an alexandrite-bearing rock for examination. These samples were purchased by an intermediary from a local dealer. The rock specimen, about 6×4 cm, was a typical biotite-phlogopite schist that showed two alexandrite crystals on the surface, with some smaller crystals almost completely covered by the matrix. Colorless to white minerals in the host rock were identified as quartz and feldspar by Raman analysis. One of the two larger crystals, about 1 cm in largest dimension, was broken. The other crystal (figure 1), of similar size, showed a thick tabular habit with dominant pinacoids b {010}, somewhat smaller pinacoids a {100} and prisms i {011}, and subordinate prisms s {120} and dipyramids o {111}. The a pinacoid was striated parallel to the c -axis.

The loose crystal weighed 70.74 ct and had a thick columnar habit with dimensions of about $18 \times 16 \times 21$ mm (figure 2). It was twinned across {031} and showed the typical parallel striations of chrysoberyl on the a and a'



Figure 1. Shown here in incandescent light, this partially transparent alexandrite crystal (approximately 1 cm wide) on biotite-phlogopite-quartz-feldspar matrix was reportedly recovered from the Mananjary area of eastern Madagascar, which is well-known as a source of emeralds; photo by M. Glas. The crystal drawing shows the faces present on this thick tabular single crystal.

{100} pinacoids. The faces listed above for the untwinned crystal were also present, but with smaller o dipyramids. The crystal showed some transparent areas from which small gems could be faceted. The b {010} pinacoids revealed a milky white area in part of the crystal that could be cut *en cabochon* to show chatoyancy. R.I.'s measured on a natural b face were 1.744–1.753. This crystal also contained inclusions of biotite-phlogopite mica platelets.

The Mananjary alexandrite samples examined by this contributor were intense bluish green in daylight with a color change to reddish or grayish purple in incandescent light (again, see figure 2). Although production figures are not known at this time, these specimens show that there is future potential for faceted and cat's-eye alexandrite from the Mananjary area. KS

Figure 2. Alexandrite from the Mananjary area shows a distinct color change, from bluish green in day or fluorescent light (left) to reddish or grayish purple in incandescent light (right), as seen in this 70.74 ct specimen. The crystal is twinned by reflection across the prism {031} and reveals the striations characteristic of chrysoberyl on the a and a' {100} faces of the twin. Photo by Maha Tannous; color corrected to show appearance in fluorescent light. The crystal drawing indicates the faces present on this thick columnar twin; the location of the twin boundary is shown by arrows.





Figure 3. Gem-quality color-change apatite was recently produced from a pegmatite in Kazakhstan. The 3.5-cm-long crystal and 2.37 ct faceted stone shown here are pinkish orange in incandescent light (left) and greenish yellow in fluorescent light (right). Photos by Jaroslav Hyrsl.

Color-change apatite from Kazakhstan. Apatite is a fairly common gem material, known from many localities in a variety of colors. Until now, however, color-change apatite has been documented only in synthetic form; it changes from purple-pink in incandescent light to violetish blue in fluorescent light (see Spring 2001 Lab Notes, p. 57). The Akzhailyau (or Akdzhala) pegmatite in eastern Kazakhstan recently produced gem-quality apatite that shows a distinct color change. The well-formed crystals range up to about 5 cm in length, and are dominated by faces of the hexagonal prism and basal pinacoid. They are typically recovered as loose single crystals, but a few specimens have been mined with the apatite attached to a feldspar matrix or intergrown with dark smoky quartz crystals. Many crystals have large clean areas that are suitable for faceting gemstones over 10 ct. However, little of the material has been faceted, as the well-formed crystals are valuable as mineral specimens.

For this study, two crystals and 10 cut stones up to 2.37 ct were examined. In incandescent light, the crystals

appeared pinkish orange and the cut stones were very pale pinkish orange to almost colorless. It was interesting to note two different color appearances in day and fluorescent light. In daylight, both crystals and cut stones were light brown, but in the fluorescent light used for diamond grading, both appeared greenish yellow (figure 3). Although uncommon, hue changes have been documented previously between daylight and daylight-equivalent fluorescent light in other gem materials (Y. Liu et al., "A colorimetric study of the alexandrite effect in gemstones," *Journal of Gemmology*, Vol. 26, No. 6, 1999, pp. 371–385).

The refractive indices of all samples were 1.631–1.634, with an unusually low birefringence of 0.003. The samples were uniaxial negative, and specific gravity values of 3.23–3.26 were obtained by the hydrostatic method. The apatite fluoresced pink to both long- and short-wave UV radiation, with stronger fluorescence to short-wave UV. Pleochroism was very weak (i.e., almost undetectable). When examined with a microscope, some stones revealed

Figure 4. The San Pedro mine in the Chivor region of Colombia is being worked by mechanized methods in an open cut. Photo courtesy of Kirk Bandy.



abundant two- and three-phase inclusions with an anisotropic solid phase. Tiny unidentified red crystals also were observed in some stones. The absorption spectrum seen with a hand spectroscope was a typical "didymium" type, identical to yellow apatite from Durango, Mexico (see, e.g., R. Webster, *Gems*, 5th ed., revised by P. G. Read, Butterworth-Heinemann, Oxford, 1994, pp. 315–316). However, the spectral lines seen in the Kazakhstan apatite were much sharper than those in a Mexican sample of the same thickness. This indicates that the apatite from Kazakhstan has a much higher concentration of rare-earth elements (REEs). This composition is consistent with the material's color-change behavior, which is also seen in other REE-containing minerals such as remondite and monazite.

A recent description of the Akzhailyau apatite indicated that the pink color fades on exposure to sunlight (see T. Moore, "Tucson show 2002," *Mineralogical Record*, Vol. 33, No. 3, p. 274). The color stability of the 12 samples examined was not tested by this contributor.

Jaroslav Hyrsl (hyrsl@kuryr.cz)
Kolin, Czech Republic

New emerald find from the Chivor region, Colombia.

Recently, Colombian Emeralds Direct of Wichita, Kansas, provided this contributor with six pieces of gem-quality emerald ranging from 1.5 to 30 ct, and two faceted emeralds weighing 1.02 and 3.81 ct, from a reactivated mine in the Chivor region (figure 4). The deposit is being worked by Sociedad Minera San Pedro in an open pit and associated tunnels. From material personally examined and photos of rough taken at the mine site (e.g., figure 5), this contributor estimates that approximately 3,000 carats of rough has been mined since May 2002.

The gemological properties of the two faceted stones (see figure 6) were consistent with those for Colombian emeralds: R.I.—1.570 or 1.571 to 1.577, S.G.—2.65 and 2.70, and inert or very weak red fluorescence to long-wave UV radiation (as determined by the GIA Gem Trade Laboratory). The inclusions were also typical of those found in emeralds from Colombia. Observations by this contributor showed that both stones contained growth tubes and multi-phase inclusions that were not well defined, as well as colorless subhedral crystals (probably albite). The larger faceted gem also showed a roiled effect. The rough contained the same inclusions as the cut stones, with the addition of euhedral pyrite crystals on the surface and within several of the pieces. Two of the crystals had small areas with white calcite matrix on the surface, also typical for Colombian emeralds.

This contributor has seen about 200 carats of faceted gems, mostly in the lighter, more commercial color range similar to the 1.02 ct stone shown in figure 6; the 3.81 ct stone in that figure shows the saturated green color representative of the best-quality material from the mine. Most of the emeralds had relatively few fractures and therefore do not need clarity enhancement.

Rudy Wobito, of Wobito Gems in Ontario, Canada,



Figure 5. Weighing approximately 2,000 carats, this parcel contains some of the better-quality emeralds that were recently mined from the Chivor region. Photo courtesy of Kirk Bandy.

has faceted a number of stones from this new material with good results. He reports that he recently cut a parcel of rough weighing 185.80 carats that resulted in 13 gems with a finished total weight of 44.58 carats. Included were an 11.34 ct medium green gem from a 50 ct piece of rough and a 9.07 ct finished gem from a 30 ct piece of rough. The range of color and good clarity of these emeralds should contribute to several different levels of the market.

Edward Boehm (joebgem@aol.com)

JOEB Enterprises
Solana Beach, California

Figure 6. These emeralds are representative of recent production from a reactivated mine in the Chivor region of Colombia. The saturated green 3.81 ct stone was examined by the GIA Gem Trade Laboratory and found to contain no evidence of clarity enhancement. The lighter green 1.02 ct sample shows the typical color of most of the faceted material obtained from the recent production. Photo by Maha Tannous.



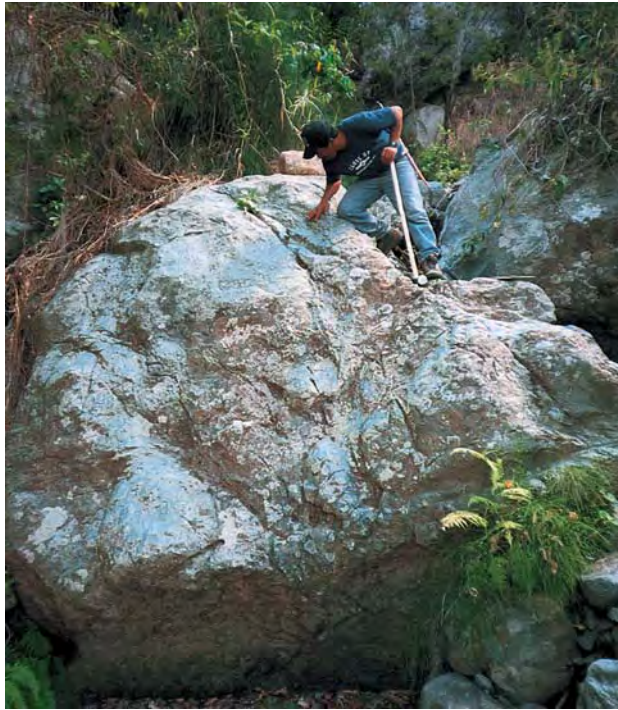

Figure 7. This large boulder of Guatemalan jadeite, estimated to weigh 340 tons, marks the discovery site of the “Olmec Imperial” material. The boulder contains 2–5 cm wide veins of green Olmec Imperial jadeite in a matrix of dark green, almost opaque jadeite. Smaller boulders containing the “New Blue” jadeite lie along the same creek. In total, the boulders are estimated to contain about 3,000 tons of jadeite. Photo by John Cleary.



Figure 8. This boulder of New Blue jadeite is cross-cut by a vein of bluish green Olmec Imperial jadeite. Photo by John Cleary.

Important discovery of jadeite in Guatemala. Guatemala has been the focus of significant media attention since the recent announcement of a “jade lode as big as Rhode Island” (see W. J. Broad, “Found in the Guatemalan wilds...,” *New York Times*, May 22, 2002, pp. A1, A10). This discovery is particularly significant because one of the new areas contains several large boulders of jadeite with narrow bands of bluish green and greenish blue that are jewelry quality (figures 7 and 8). Local jade hunters discovered the boulders in the mid-1990s, in rugged terrain about 40 km west of Chiquimula (figure 9). The significance of the discovery was recognized more recently, following the exposure of new jadeite outcrops and alluvial boulders by torrential rains that accompanied Hurricane Mitch in October 1998.

Figure 9. Guatemalan jadeite deposits are hosted by serpentinites located within and adjacent to the Motagua fault zone. The Motagua river valley follows the trace of the fault zone.

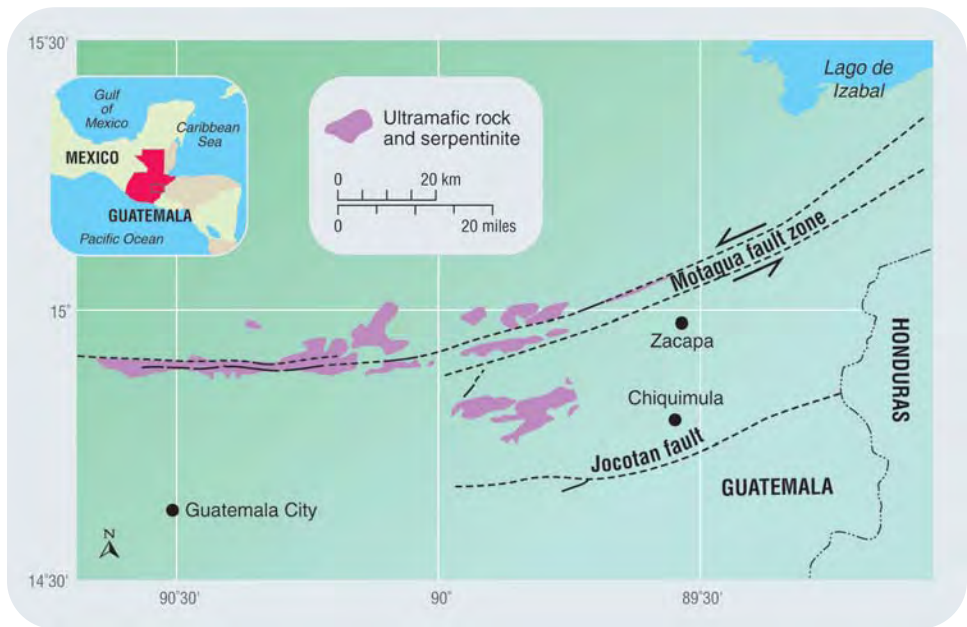

These contributors have been involved in field exploration for Guatemalan jadeite with Ventana Mining Co. since January 2001. The discovery area reported by the *New York Times* lies in the Motagua river valley about 80 km northeast of Guatemala City (figure 9). All of the jade deposits known in Guatemala are found within or near the Motagua fault zone (MFZ), an east-west-trending boundary between the North American and Caribbean tectonic plates; this area is active today as a zone of left-lateral faults. Along and adjacent to this zone, numerous sheared serpentinite bodies are present in an area 10–40 km wide and 100 km long (again, see figure 9). Jadeite occurs within the serpentinites as veins, lenses, and pods a few meters wide and up to tens, or even hundreds, of meters long. These primary jadeite bodies are the sources of the alluvial boulders found throughout the region. The jadeite is thought to have crystallized directly from a hydrous fluid at pressures of 5–12 kbar and temperatures of 200°–450°C (V. B. Sisson et al., "Jadeite and eclogite occurrences along the Motagua Suture Zone, Guatemala," *Programme with Abstracts*, 18th General Meeting of the International Mineralogical Association, Edinburgh, Scotland, September 1–6, 2002, pp. 221–222).

The recent finds of bluish green jadeite are similar to the type associated with royalty in the Olmec culture. As such, these contributors describe this new material as "Olmec Imperial" jadeite (figure 10). It has also been called the local term in Spanish for "green vein" in the field. From an examination of 12 polished samples, we noted that this material shows a significantly darker tone in reflected light compared to its appearance in transmitted light, and was translucent up to a thickness of 5 mm. Spot R.I. values were 1.65 to 1.68 and the S.G. (determined hydrostatically) ranged from 3.27 to 3.34.

A different material (see figure 11), termed "New Blue" jadeite by these contributors has been found for the first time in the field. This bluish green to greenish blue jadeite is called various names by local prospectors, including the terms in Spanish for "celestial blue" and "window blue." This material is entirely different from the "Olmec Blue" jade (a green jadeite, typically of low saturation) previously described in the gemological and archaeological literature (see, e.g., R. Seitz et al., "'Olmec Blue' and formative jade sources: New discoveries in Guatemala," *Antiquity*, Vol. 75, 2001, pp. 687–688).

Dr. Robert Coleman of Stanford University has confirmed from petrographic and geochemical analysis that the New Blue material is 95% jadeite with small amounts of phengite mica, sphene, albite, and zircon (pers. comm., 2002). This is consistent with our examination of five polished samples, which yielded S.G. values from 3.32 to 3.34 and R.I.'s of 1.66 to 1.68. The material was translucent up to a thickness of 12 mm. The samples were dark bluish green in reflected light, and medium-light bluish green to greenish blue in transmitted light. The blue color compo-



Figure 10. Olmec Imperial jadeite (here, 1.89–5.51 ct) is strongly saturated bluish green in transmitted light. Courtesy of Ventana Mining Co.; photo by Maha Tannous.

nent is due to Fe^{2+} - Ti^{4+} intervalence charge transfer, whereas the green is produced through Fe^{2+} and Fe^{3+} absorptions (G. Harlow, pers. comm., 2002).

Recovery of both the Olmec Imperial and the New Blue jadeite by local jade hunters has historically been only from creek beds and alluvial terrace deposits downstream of the giant boulders. The local jade hunters sell most of their rough to the several jewelry manufacturers in Antigua, Guatemala. These manufacturers sell almost all of their jewelry to the local tourist trade.

John G. Cleary and
William R. Rohtert
(william.rohtert@ventanaming.com)
Ventana Mining Company, Reno, Nevada

Figure 11. These cabochons (4.01–15.05 ct) show the typical bluish green to greenish blue color of the New Blue jadeite. Courtesy of Ventana Mining Co.; photo by Maha Tannous.





Figure 12. This 1.66 ct very light yellow cut-cornered, rectangular step cut purchased in Madagascar was identified as milarite. Photo by A. Cossard.



Figure 13. The milarite shown in figure 12 is filled with unusual very thin, elongate inclusions, which locally appear interrupted. Photomicrograph by Emmanuel Fritsch; magnified 7x.

Faceted milarite with unusual inclusions. A 1.66 ct very light yellow cut-cornered, rectangular step cut (figure 12) was purchased in Madagascar by Richard Lejeune, of Charleville-Mézière, France. The stone was assumed to be of Madagascar origin, but the seller did not know its identity, so it was brought to this contributor for identification. The R.I. was 1.53 and the S.G. was 2.53. The stone was isotropic on the refractometer, regardless of the facet selected for measurement. When examined between crossed polarizers, the stone showed a band of second-order interference colors (blue to yellow) along its length. With long-wave UV radiation, the stone fluoresced a medium, slightly chalky green, followed by weak phosphorescence in the same color for 30 seconds to one minute. With short-wave UV, it fluoresced a medium whitish green followed by long-lasting greenish phosphorescence (i.e., for about three to five minutes). It was not a thermal conductor and was not magnetic. Based on the perfect isotropy on the refractometer, the R.I., the S.G., and the interference colors between crossed polarizers, the logical conclusion would be pseudocubic apophyllite. However, the color of the stone, as well as the absence of the common iridescent cleavages

of apophyllite, made that conclusion doubtful.

A Raman spectrum was obtained using a Bruker RFS100 FT laser Raman spectrometer, with a resolution of 4 cm^{-1} . The most intense peak was at about 480 cm^{-1} , with weaker ones at about 1123, 538, and 130 cm^{-1} , a strongly orientation-dependent feature at 288 cm^{-1} , and minor peaks at 835, 383, 350, 324, and 161 cm^{-1} . This spectrum closely corresponds to the milarite reference in the database of the gemology laboratory at the University of Nantes. The reference spectrum for apophyllite is completely different, with main Raman peaks at about 1060, 664, 585, 433, and 211 cm^{-1} . These results were very surprising, as the few milarites measured previously by Yves Lulzac from Nantes always had two distinct R.I.'s, even if the birefringence was weak (about 0.003–0.004).

Milarite ($\text{KCa}_2\text{AlBe}_2\text{Si}_{12}\text{O}_{30}\cdot 0.5\text{H}_2\text{O}$) is a hexagonal mineral belonging to the osumilite group. To confirm the identification, quantitative chemical analyses of the stone were performed with a JEOL 5800LV scanning electron microscope (SEM) equipped with a PGT (Princeton Gamma Tech) energy-dispersive IMIX-PTS detector. The chemical compo-

Figure 14. This water-worn spinel crystal from the Tunduru area in Tanzania has a very unusual dodecahedral shape. Approximately 6 mm across, it weighs 1.87 ct. Photo by H. A. Hänni.



Figure 15. Spinel typically crystallizes as simple octahedra, as shown by these two examples from Mogok, Myanmar (left) and Pelmadulla, Sri Lanka (right). Each crystal measures approximately 6 mm across; photo by H. A. Hänni.



sition was (in wt.%): 4.72 Al₂O₃, 71.73 SiO₂, 4.89 K₂O, and 11.18 CaO, for a total of 92.52 wt.% (beryllium and hydrogen cannot be detected with this system). This compares favorably with the analysis published by C. Palache ("On the presence of beryllium in milarite," *American Mineralogist*, Vol. 16, No. 10, 1931, pp. 469–470).

The most striking characteristic of this stone was its inclusions (figure 13). The stone was filled with randomly oriented, thread-like inclusions that were about 1 µm or less wide and typically 1–2 mm long. Their cross-section seemed somewhat rectangular. Under certain lighting conditions, some appeared as interrupted lines, although they were continuous. Attempts to identify these inclusions by Raman analysis gave no spectra other than milarite. Therefore, the inclusions were either too small to be identified by this method, or they were empty tubes. This contributor could not find any surface-reaching inclusions to study with the SEM, so their true nature remains a mystery. EF

Spinel crystal with an unusual shape. The SSEF Swiss Gemmological Institute received a parcel of rough stones from Tunduru, Tanzania, that contained a water-worn light violet crystal of dodecahedral shape (figure 14). From its shape and color, one might expect this crystal to be a color-change garnet; however, the stone showed no color change. One face had been polished to facilitate a refractive index reading, which was 1.718. Between crossed polarizing filters, the crystal showed no double refraction. Specific gravity (measured hydrostatically) was 3.56. From all these observations, we identified the mineral as spinel, which was further confirmed by Raman analysis. EDXRF spectroscopy showed Mg and Al as main constituents, with traces of Fe, Ti, Mn, Zn, and Ga.

All of these properties were consistent with spinel, except for the crystal's shape. According to mineralogy reference books (see, e.g., W. L. Roberts et al., *Encyclopedia of Minerals*, 2nd ed., 1990, Van Nostrand Reinhold, New York), crystals of spinel are usually octahedral (figure 15), but in rare cases they may form cubes or dodecahedra. If routine gemological properties are not taken, spinel crystals such as this one might easily be mistaken for garnet.

HAH

More tourmaline from Warner Springs, California. The Winter 2001 GNI section (pp. 338–339) reported on a remarkable discovery of large, well-formed pink tourmaline crystals from the Cryo-Genie mine in north-central San Diego County. The showpiece specimen from that find, a 25-cm-long (after repair) crystal of tourmaline on quartz, was purchased by the Los Angeles County Museum of Natural History.

A new gem pocket was discovered in August–September 2002 by mine owners Dana and Ken Gochenour, mine engineer Jim Clanin, and partner Dave Kalamas. The deposit has continued to be mined on a small-scale basis, via drilling and blasting tunnels into the



Figure 16. At 18.1 cm long, this bicolored, doubly terminated tourmaline is representative of some of the fine-quality crystals that were found in August–September 2002 at the Cryo-Genie mine near Warner Springs, California. Photo © Jeff Scovil.

pegmatite. The lower drift was extended approximately 4 m into barren pegmatite to reach an area lying down-dip of the large pocket found in October 2001. There, small cavities containing pencils of gemmy, bluish green tourmalines led the miners to two clay-rich areas that joined together into a large pocket measuring approximately 2.2 × 1.2 × 1 m. Numerous matrix specimens of translucent to transparent smoky quartz on cleavelandite feldspar were recovered from the sticky reddish brown clay. Less common, but more spectacular, were large (up to about 30 cm long), well-formed crystals of pink and bicolored pink-green tourmaline (see, e.g., figure 16). Several of the



Figure 17. These Nigerian tourmalines (3.43–9.65 ct) illustrate the color variety of some of the samples that were chemically analyzed and identified as elbaite and/or liddicoatite. Rossmanite also was found in portions of two of the stones (the 3.69 ct tricolored emerald cut in the lower center and the 7.50 ct pink/green cushion cut to the upper right). Courtesy of Pala International and Barker & Co.; photo © Harold & Erica Van Pelt.

crystals were doubly terminated, with flared pinacoidal terminations similar to those reported in the Winter 2001 GNI item. GNI editor Brendan Laurs witnessed the removal of one such tourmaline that was broken by natural forces into several pieces. The miners were careful to excavate all of the pocket contents so that the broken pieces of such crystals could be reconstructed. Portions of the largest crystal found were broken beyond repair, but gem-quality pink material in its interior is expected to yield several hundred carats of faceted stones and cabochons. In addition, 50 bluish green stones ranging up to about 1 ct have been cut. The polished goods will be sold individually and set in custom jewelry.

Faceted rossmanite and other tourmalines from Nigeria. Recent chemical analyses have shown the occurrence of liddicoatite in faceted stones and slices of Nigerian tourmaline that were produced in the late 1990s (see Gem News International, Summer 2001, pp. 152–153, and Fall 2001, pp. 240–241; “Liddicoatite tourmaline from Anjanabonoina, Madagascar,” D. Dirlam et al., Spring 2002, pp. 28–53; and the *G&G* Data Depository at www.gia.edu/pdfs/table2.xls). Over the past several months, we have had the opportunity to analyze many additional faceted samples of tourmaline from the Ibadan area in western Nigeria.

A comprehensive color suite containing 100 stones with a total weight of 565 carats was loaned to GIA by Bill Larson (Pala International, Fallbrook, California) and Bill Barker (Barker & Co., Scottsdale, Arizona). This collection was assembled from rough that was produced during 1998–2000. Fifty of the stones that were representative of the entire color range were chosen for electron microprobe analysis at the University of New Orleans; some of these are shown in figure 17. The face-up colors ranged from pinkish orange to pink to purplish red, red-orange, pale yellow to yellowish green and dark green, bluish green, grayish blue, and near colorless. Some of these hues resulted from the combination of two different colors (e.g., pink and green) in stones that were cut so that the table was not perpendicular to the color boundary. Seven distinctly bicolored or tricolored stones with pink to red, green, greenish

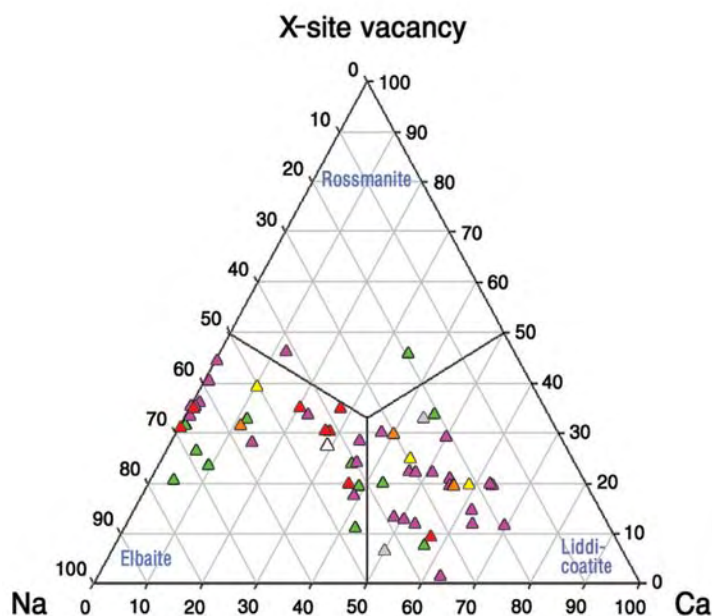

Figure 18. Electron microprobe analyses of 100 Nigerian tourmalines of various colors show that they were predominantly elbaite and liddicoatite; note also the two analyses of rossmanite. The color of each data point roughly approximates the color of the area analyzed. There is no correlation between X-site occupancy and color.

blue, bluish gray, and near-colorless zones also were analyzed. Generally, five analyses were obtained from each stone, or from each major color zone in the multicolored samples.

The data summarized in figure 18 represent averages of each stone or color zone analyzed, and show that approximately half the analyses correspond to elbaite and half to liddicoatite compositions. We were pleasantly surprised to discover that two analyses fell within the rossmanite field, making this the first time we have documented this rare tourmaline species in faceted stones. Rossmanite, named in honor of California Institute of Technology professor (and *G&G* Editorial Review Board member) George Rossman, was recognized as a new lithium-aluminum tourmaline species in 1998, and is characterized by an elemental vacancy in the X site (see Fall 1998 Gem News, p. 230). A few faceted examples of rossmanite (in colorless to pale pink) are also known from the island of Elba, Italy (F. Pezzotta, pers. comm., 2003).

As documented previously by Dirlam et al. (2002), the analyses showed no systematic correlation between color and X-site occupancy; that is, there was no correlation of color with the identification of the material as elbaite, liddicoatite, or rossmanite. The two samples containing rossmanite (again, see figure 17) were analyzed in more detail to better define the distribution of this species. Rossmanite was detected in some analyses of the green portion of a 3.69 ct tricolored (green–near colorless–pink) emerald cut, and liddicoatite was found in both the green and pink portions of this stone. The other sample containing rossmanite (in a pink area) was a 7.50 ct pink/green cushion that consisted mostly of elbaite. In both cases, the analyses fell fairly close to the border of the rossmanite field (again, see figure 18).

Some additional samples of Nigerian tourmaline from the Ibadan area—showing unusual coloration—were loaned by Mark Kaufman (Kaufman Enterprises, San Diego, California). Included were three particolored rectangular step cuts (1.39–1.70 ct) and two particolored crystals from the same parcel, as well as a bright orange 7.85 ct elongate cushion accompanied by a piece of rough of identical color (see, e.g., figure 19). Electron microprobe analysis of the orange rough showed that it was elbaite with 4.92 wt.% MnO and 0.42 wt.% TiO₂; iron was below the detection limit of 0.016 wt.% FeO. All three of the particolored stones were liddicoatite, with the exception of one area with an elbaite analysis that fell very close to the liddicoatite field. Interestingly, the color zones in this tourmaline were oriented perpendicular to the c-axis, rather than being parallel to a pyramidal direction as is the case with liddicoatite from Madagascar. The colors of these five Nigerian liddicoatites also were less pronounced and showed a narrower range of hues (in colorless to pink, yellowish green, or bluish green) than their Malagasy counterparts.



Figure 19. These particolored tourmalines (1.39–1.70 ct faceted, as well as 5.82 and 10.06 ct crystals) from Nigeria show color zoning perpendicular to the c-axis. Chemical analysis of the faceted stones proved that they were liddicoatite (with the exception of one area that gave an elbaite analysis). The bright orange color of the 7.85 ct Nigerian sample in the inset is unusual for tourmaline. Chemical analysis of a rough sample of identical color showed an elbaite composition with appreciable amounts of manganese, traces of titanium, and no detectable iron. Courtesy of Mark Kaufman; photos by Maha Tannous.

Uvite tourmaline from Afghanistan. Beautiful gem tourmalines have been commercially available from Afghanistan for nearly three decades, typically in pink, green, and blue hues. Available chemical analyses indicate that these tourmalines are of the elbaite species (see, e.g., R. Leckebusch, “Chemical composition and colour of tourmaline from Daræ Pich (Nuristan, Afghanistan),” *Neues Jahrbuch für Mineralogie, Abhandlungen*, Vol. 13, 1978, pp. 53–70).

In July 2002, Sir-Faraz (“Faroq”) Hashmi of Intimate Gems, Jamaica, New York, sent GIA some brownish orange samples from Afghanistan that were tentatively identified as either tourmaline or bastnäsite. Included in this donation were two faceted stones (0.59 and 1.46 ct) that were cut for our research by John Bailey (Klamath Falls, Oregon), several loose crystals, and two specimens of the brownish orange crystals in a white, talc-like matrix (figure 20). Mr. Hashmi was told by Gaus-ud-din, an Afghan partner, that the material was mined from the “Wata Poore” area in Konar Province. Reportedly a few dozen kilograms of the material has been mined, although production has slowed in recent months due to the unrest in the region.

The crystals were equant and lacked the striations on their prism faces that are typically seen on tourmaline from Afghanistan and elsewhere, and the mineralogy of the matrix material indicated that it was not derived from a granitic pegmatite. Nevertheless, standard gemological

BML
William “Skip” Simmons and Alexander Falster
University of New Orleans, Louisiana



Figure 20. These samples of brownish orange uvite tourmaline were reportedly mined from Kunar Province, Afghanistan. The equant, well-formed crystals are found in a soft, white, talc-like matrix. The two cut stones weigh 0.59 and 1.46 ct. Courtesy of *Intimate Gems*; photo by Maha Tannous.

properties obtained on the two faceted stones indicated that they were tourmaline (i.e., uniaxial negative optic character, R.I.—1.620–1.641, birefringence—0.021, and S.G.—2.99 and 3.04). Microscopic examination revealed abundant mineral inclusions of colorless to white, anhedral, birefringent particles; partially healed fractures; and “feathers.” A few dark brown (nearly black), transparent inclusions also were present. The stones were inert to long-wave UV, and showed a chalky greenish orange fluorescence of moderate intensity to short-wave UV radiation.

To better characterize these unusual tourmalines, one of the crystals was analyzed by electron microprobe at the University of New Orleans. The sample proved to be uvite, a Ca-Mg tourmaline that is uncommon in facetable quality. The six analyses revealed a rather homogeneous composition, with an appreciable dravite component (as shown by the presence of 1.35 wt.% Na₂O). In addition, the analyses showed an average of 1.14 wt.% TiO₂, 0.06

wt.% FeO, and 0.50 wt.% F. Polarized visible-range spectroscopy of one sample showed that the brownish orange color is due to a combination of Fe²⁺-Ti⁴⁺ intervalence charge transfer and Fe²⁺ (G. Rossman, pers. comm., 2003).

BML

William “Skip” Simmons and Alexander Falster
University of New Orleans, Louisiana

SYNTHETICS AND SIMULANTS

An assembled agate “nodule.” This contributor was recently shown an unusual agate that was reportedly purchased in 2002 at an agate mine near Lhasa, Tibet (figure 21). After the owner returned to the U.S., he noticed that the agate slab had separated from its matrix, revealing its assembled nature.

The thin slab of translucent agate was backed with pink tissue paper and attached to a piece of granitic rock (probably rhyolite). A clay “bezel” had been built up around the slice. The slice was apparently polished after it was assembled, since there were traces of what appeared to be chrome oxide in the porous areas of the agate and the matrix. The green color of this polishing residue resembled that shown by celadonite, a clay-like mineral that commonly forms in association with agate nodules.

This contributor has been involved with research on agates for about 40 years (see <http://csd.unl.edu/csd/programs/agateres.html>), and has never seen such a specimen before. Considering the poor quality of the agate slice, it is surprising that someone would take so much time to forge the specimen. This does point out, however, that buyers should exercise caution even when purchasing the most inexpensive stones. It is conceivable that forgers might assemble such stones from slices of finer agates such as those from northern Mexico, which can command high prices.

Roger K. Pabian (rpabian1@unl.edu)
University of Nebraska, Lincoln

A glowing manufactured gem. At the 2002 Tucson gem show, this contributor encountered a unique new manufactured material that was represented as “Nightglow Stone.”

Figure 21. The sliced agate “nodule” on the left (10–12 cm in diameter) was recently purchased at a mine in Tibet.

On the right, the assembled nature of the specimen is revealed. A thin slice (5 mm) of agate was backed by pink tissue paper, and embedded in a layer of clay adjacent to the rock matrix. Photos by Roger K. Pabian.



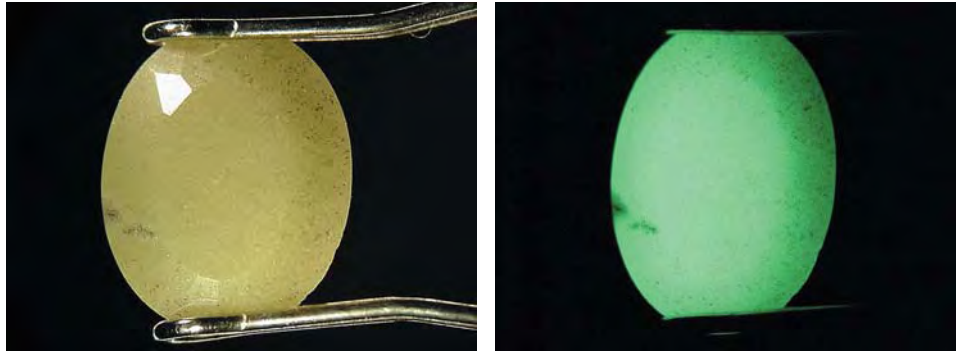

Figure 22. Marketed as “Nightglow Stone,” this new greenish yellow manufactured gem (left, 1.40 ct) displays particularly strong, long-lasting phosphorescence (right). Photos by T. Hainschwang.

The faceted samples had a greenish yellow body color and were translucent with a rather low luster. Some contained small black inclusions. Their most distinctive feature was a persistent, very strong green phosphorescence that occurred even after brief exposure to light (figure 22). According to the dealer, the material was produced by a company in China. These characteristics are consistent with the “Qinglong Luminescent Gem” reported by N. Shi and Q. Hao (“A new material for artificial stone . . .,” *China Gems*, Vol. 10, No. 3, 2001, p. 24). The dealer indicated that the chemical composition was SrAl_2O_4 plus boron, dysprosium (Dy), and europium (Eu) oxides.

This contributor purchased two faceted samples and borrowed two additional ones for examination. The 1.40–2.15 ct samples contained various amounts of black impurities. For safety reasons, they were checked for radioactivity with a Geiger counter; none was radioactive. Then, phosphorescence was checked by exposing one of the samples to a strong fiber-optic light for 10 minutes and placing it in a dark safe. Amazingly, it still showed a weak green glow after 14 hours in darkness.

Standard gemological examination and hardness testing using hardness points (on three samples) gave the following properties: R.I. (average)—1.655, optic character—*isotropic*, S.G.—3.46–3.55, and hardness—5.5–6. When exposed to both long- and short-wave UV radiation, the material exhibited a strong yellowish green fluorescence, and a strong and persistent green phosphorescence.

Microscopic observation revealed that the material was granular and inhomogeneous. High magnification (up to approximately 800 \times) was used to resolve the individual grains in reflected light (figure 23). The microstructure suggested that the material was not grown by conventional methods, but was produced by sintering; this process was also mentioned by Shi and Hao (2001). In sintering, a granular or powdered substance is solidified through the application of heat and pressure.

Visible–near infrared spectra were recorded for three of the four samples in a range of 400–1000 nm. Several absorption peaks between 750 and 915 nm were present. The position and appearance of these absorptions indicated that they were caused by rare-earth elements. The phosphorescence spectrum of one sample showed a broad emission band with its maximum intensity at 524 nm.

Photoluminescence spectroscopy of two samples was

performed using a Raman spectrometer equipped with a 532 nm laser. Several peaks between 650 and 735 nm were present, with a dominant peak at 693.5 nm. These peaks are similar to those shown by corundum, which are due to traces of Cr. Thus, rather low concentrations of Cr appear to be present in this manufactured material.

FTIR spectra of three samples were recorded in the range of 7800–350 cm^{-1} . Weak OH-related peaks were detected at about 6200 cm^{-1} and between 3500 and 2100 cm^{-1} , similar to the features seen in some glasses due to hydration. However, reflectance FTIR spectra of two samples revealed several sharp peaks between 1000 and 350 cm^{-1} (figure 24), which are indicative of an aggregate-like crystalline structure rather than a glass.

Semi-quantitative chemical analysis of one sample was then performed using a Zeiss SEM-EDX system. The imaging capabilities of the scanning electron microscope revealed the individual grains and the presence of several different phases (figure 25). In addition, in backscattered electron (BSE) images such as this, the quantity of electrons backscattered from a given surface is proportional to the mean atomic number of the material. Thus, the light-colored areas in figure 25 contain the heaviest elements, while those of darker color have the lightest atomic weight. Six point analyses (2

Figure 23. At high magnification (here, 200 \times), the individual grains constituting the luminescent material become visible. Photo by T. Hainschwang; reflected light.

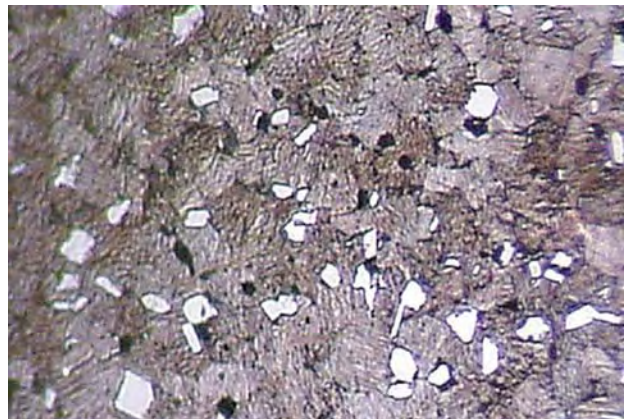

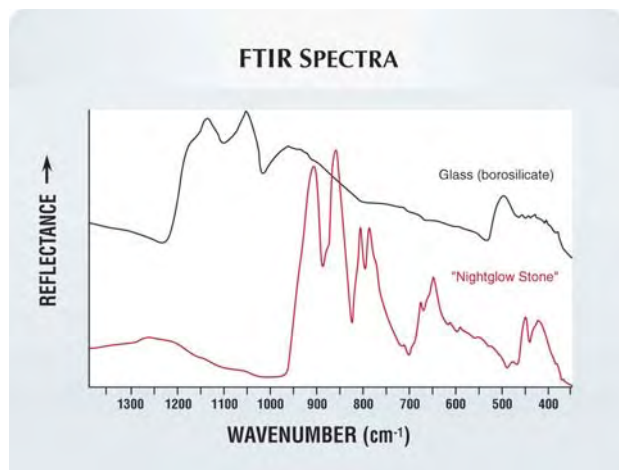
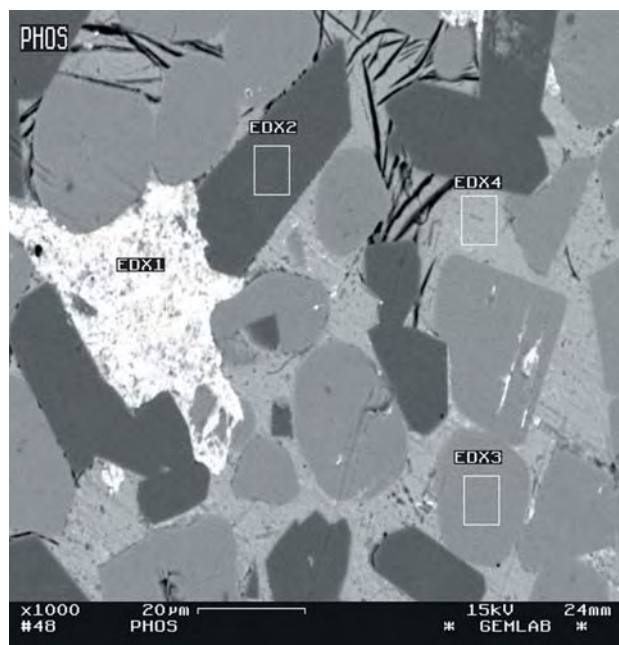

Figure 24. The reflectance FTIR spectra show obvious differences between glass and the phosphorescent material. The sharp peaks are indicative of an aggregate-like crystalline structure, rather than a glass.

μm diameter) were performed to investigate all of the apparent phases present. All of the elements in the composition stated by the dealer were verified except boron, which cannot be analyzed by this instrument. Analysis of the light

Figure 25. This BSE-SEM image (1,000×) of the phosphorescent material reveals the presence of several phases, as light and dark areas corresponding to over-all atomic weight. Light tones correspond to heavy elements, and dark tones indicate light elements. Specific areas that were chemically analyzed are labeled (see text).



areas (e.g., EDX 1 in figure 25) revealed Pb, Cr, and Sb. The black impurities (as seen in standard viewing conditions) had unusually high contents of Eu and Dy, and appear to be unmelted or exsolved additives of the rare-earth dopant. Some grains (mottled light and dark gray in the BSE-SEM images) had a high content of Zn; the origin and role of this impurity is unclear.

The majority of grains analyzed (e.g., EDX 2, 3, and 4 in figure 25) showed only Sr and Al in various proportions, representing around 90% of the ingredients detected. The color of these grains in the SEM images directly relate to the ratio of Sr to Al: the lighter the tone, the higher the Sr content.

The Nightglow Stone appears to be produced by a sintering process with a ceramic phosphor (doped with rare earths) as the main ingredient. This contributor has learned that a crystalline powder of SrAl_2O_4 (strontium aluminate) doped with Eu^{2+} and Dy^{3+} has been produced (mainly in China and Japan) by the floating-zone technique. This so-called ceramic phosphor is greenish yellow, nontransparent, and exhibits a very long lasting green phosphorescence, so it appears likely that it forms the main ingredient in these manufactured gems. The addition of boron (a fluxing agent) may help transform the non-transparent powder into a translucent glassy substance during the heating process. The role of Cr, Pb, and Sb is unclear, but they may represent impurities in the ceramic or part of a flux involved in the production process.

Thomas Hainschwang (gemlab@adon.li)
Gemlab Gemological Laboratory
Vaduz, Principality of Liechtenstein

“Rainbow Calsilica.” At the June 2002 mineral show in Saint Marie aux Mines in France, we saw a beautifully colored necklace consisting of polished pieces of a fine-grained, banded opaque material called “Rainbow Calsilica.” We purchased two samples of similar material for examination, 46.11 and 36.14 ct (figure 26). The dealer claimed that the material came from the U.S. and had been around for several years. He supplied a photo of the “mine” showing a thin, near-vertical vein of colored material, as well as a letter of authenticity from a private laboratory based in Arizona. This letter stated that the Rainbow Calsilica was composed of microcrystalline calcite, with the amorphous clay mineral allophane as the binding material; the pigmentation was associated with the allophane. The U.S. distributor of this material told these contributors that it was believed to have come from Chihuahua, Mexico. The color was reportedly the result of a “copper push” that cross-cuts rhyolite.

Macroscopically, the material showed irregular bands of blue, green, light yellowish green, yellow, orangy yellow, white, black, and reddish brown, and somewhat resembled the brightly colored sands found in bottles in curio shops. The width of the bands ranged from 0.1 to 2.7 mm, with variations not only between the bands, but also

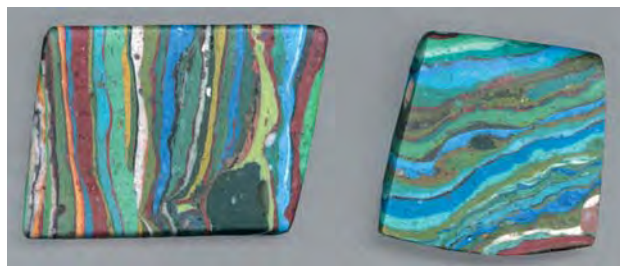

Figure 26. These two pieces of “Rainbow Calsilica” weigh 46.11 and 36.14 ct. The larger sample is 35.6 mm long. Photo by Lore Kiefert.

within a given band. In places, rounded “droplets” with the same granular texture as the surrounding bands, but of a different color, were present.

The S.G. values of the samples (measured hydrostatically) were 1.88 and 1.92. The fluorescence depended on the intensity of the color. When exposed to long-wave UV radiation, white bands fluoresced white, light green and light blue bands fluoresced a weaker white, and brown and black bands were inert. A similar, but weaker, result was observed with short-wave UV.

With the gemological microscope, we were able to distinguish broken, irregularly shaped, and sometimes rhombic white grains in all of the colored bands. Also present were grains of various colors (figure 27), the quantities and proportions of which corresponded to the overall color and intensity of each layer. Blue bands contained dark blue grains and, in some cases, thin layers of concentrated color (figure 28), along with white grains and a colorless bonding material. The green bands contained yellow as well as blue pigments. Occasionally, we observed a transparent band of a soft plastic-like material, sometimes with bubbles, between the colored bands and in irregular patches (again, see figure 28). Bands and other areas that appeared black to the unaided eye were dark grayish green with 50× magnification, and showed a multitude of different-colored grains, transparent plastic-like areas, and pigments.

EDXRF analyses with a Tracor Spectrace 5000 energy-dispersive X-ray fluorescence spectrometer showed that Ca was the major constituent (approximately 80%–90%) in two randomly chosen bands, as well as in representative layers of various colors (i.e., blue, green, reddish brown, and black). Minor constituents were Si, Ba, and Fe (similar values in all samples). In addition, there was approximately 1%–2% Sr in the blue, brown, and green bands. A black band contained over 13% Sr. Traces of Mg, Al, P, S, Cl, Mn, Cu, Zn, and As were detected in various amounts, with no obvious correlation to color.

Analysis with a Renishaw Raman System 1000 microspectrometer showed that the white grains were calcite. This mineral was also a major constituent of the fine-grained groundmass. Analysis of two red layers showed the presence of hematite, which was consistent with the color of these bands. Celestine (SrSO_4) was identified in the black areas, and is likely the cause of the high Sr content mea-



Figure 27. White grains of various sizes are present in all of the color layers of the Rainbow Calsilica, together with smaller grains of blue, green, yellow, and other colors. Photomicrograph by Lore Kiefert; magnified 50×.

sured with EDXRF. Raman analysis of concentrated blue areas within blue layers gave the strongest peaks above 1300 cm^{-1} (figure 29, left), which suggests that this material is organic. When this Raman spectrum was compared to those of 20th century blue artists’ pigments, the material was identified as a copper phthalocyanine pigment called PB15 (again, see figure 29), a synthetic pigment that was developed in the 1930s. Similarly, the light greenish yellow

Figure 28. A thin layer of concentrated blue color is visible in this view of the Rainbow Calsilica, as are areas of yellow pigment and a clear plastic-like material; the arrow points to a bubble. Photomicrograph by Lore Kiefert; magnified 100×.

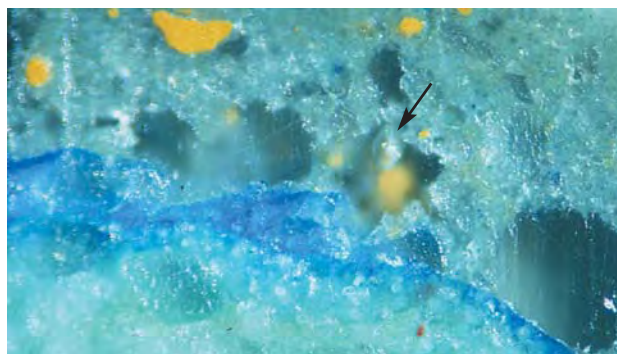

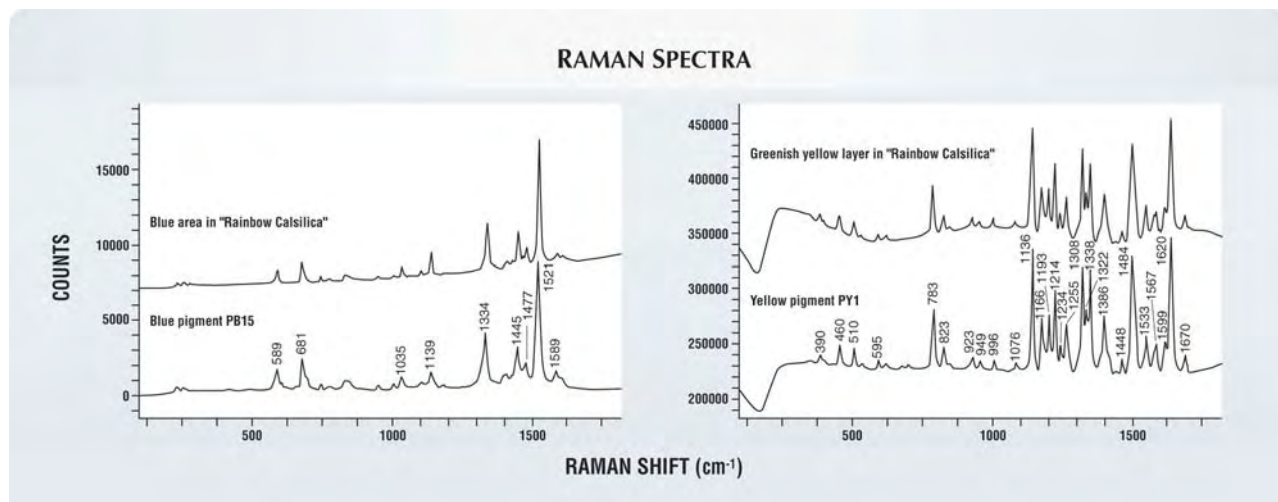

Figure 29. The Raman spectrum of the blue pigment in Rainbow Calsilica is identical to that of the blue copper phthalocyanine pigment PB15 (left), and the spectrum of the yellow pigment matches that of the yellow mono-azo pigment PY1 (Hansa Yellow; right).

areas contained the yellow mono-azo pigment PY1 (or Hansa Yellow; see figure 29, right). The other colored bands contained one or both of these pigments to produce the corresponding color. For more on the Raman spectral characteristics of artists' pigments, see P. Vandenabeele et al., "Raman spectroscopy of azo-pigments used in art," *Journal of Raman Spectroscopy*, Vol. 31, 2000, pp. 509–517.

Infrared spectra of the colorless areas and layers were taken with a Phillips PU9800 FTIR spectrometer. The spectra revealed features similar to paraffin wax, together with some additional, unidentified absorption bands. Raman analysis also showed peaks that are consistent with paraffin, with the major bands at 2928 and 2868 cm^{-1} . Additional peaks were observed at 1444, 1462, and 1732 cm^{-1} (paraffin), as well as at 1279, 1306, and 1352 cm^{-1} (due to unknown phases). Despite the spectral similarities to paraffin, the material was more elastic and it appears that the substance is an aliphatic polymer or a paraffin derivative mixed with other compounds unknown to us.

Our examination of the two Rainbow Calsilica samples proves that this is a manufactured material. Specifically, the presence of synthetic pigments and of a paraffin-like substance precludes a natural origin. The latter substance has apparently been used to stabilize the material; samples that lack this polymer reportedly separate easily along some of the color layers (S. F. McClure, pers. comm., 2002). Our samples appear to have been made of pulverized carbonate rock that was mixed with pigments and stabilized with a polymer.

Lore Kiefert (*gemlab@ssef.ch*)
 SSEF Swiss Gemmological Institute, Basel
 Peter Vandenabeele, Ghent University
 Ghent, Belgium
 Jörg Hänni, Basel

Note: PV is grateful to the Flanders (FWO-Vlaanderen) fund for supporting his postdoctoral fellowship on Raman spectroscopy.

TREATMENTS

Heat treatment experiments on faceted amber. Since the 1990s, several reports have described the effect of heat on the properties of amber (see, e.g., Summer 1993 Lab Notes, pp. 122–123; P. Hutchins and G. Browne, "New amber treatment," *Australian Gemmologist*, Vol. 19, No. 7, 1996, p. 302; and the Lab Notes entry on pp. 341–342 of this issue). These studies have documented a darkening of color with corresponding increases in R.I. values due to heat treatment, as well as orange fluorescence to long-wave UV radiation and tiny gas bubbles just below the surface. Additional studies were recently performed by this contributor on samples of faceted amber, so that detailed R.I. measurements could be obtained.

The six samples of faceted Baltic amber ranged from 3.2 to 13.8 ct. All were the same pale yellow color before the heating experiments, and infrared spectroscopy confirmed that they were amber. One of the stones was retained for reference, and the other five were heated for up to 48 hours at temperatures up to 200°C in a nitrogen atmosphere.

With increasing duration and temperature of heating, the color of the samples changed from pale yellow to orange to dark brown (see figure 30 and table 1).

A systematic increase in R.I. was measured in the darker colors, and some of the readings showed anomalous optical behavior. The untreated sample showed an R.I. value of 1.54, which is typical for amber. The highest R.I. value, at 1.62, was recorded for the darkest sample. Sample 2 showed double lines, and sample 4 showed more than 10 lines in the refractometer between 1.54 and 1.59 (figure 31). Samples 3 and 4 yielded multiple R.I.'s, but only when the stones were rotated; the R.I. variations appeared to correlate to unevenness of color. If only the polarizer was rotated, the R.I. of those samples remained constant, as expected for a singly refractive material.

To investigate the extent of the color penetration, sam-

ples 4 and 6 were cut in half. In both cases, a thin layer (i.e., less than 1 mm) of brown color was present near the surface; this layer was much darker in sample 6. Below this layer, each stone showed the original pale yellow color. The core of each sample yielded the expected R.I. value of 1.54.

In this contributor's experience, many of the so-called sun-spangled ambers, as well as ambers with an orange hue that have become increasingly popular in the market, have R.I. values ranging up to 1.555. This is consistent with the use of a heating process.

It is reasonable to infer that the organic structure of amber is modified by heat treatment. However, the exact mechanism by which the color, R.I., and other properties are changed still requires further research.

Morley Sheng-Hong Chang
(perfectgem2000@pchome.com.tw)
Perfect Jewelry Co., Taichung, Taiwan

An update on Be-diffused corundum. Over the past year, GIA has published several items on the gemological properties and chemical composition of the yellow to orange to orangy pink and orangy red corundum (figure 32) that is being produced in Thailand by treating sapphires from different localities (see Spring 2002 Gem News International, pp. 86–90; Fall 2002 Lab Notes, pp. 254–255 and pp. 255–256; and the *GIA Insider* [www.gia.edu/wd_349.htm] on January 28, February 15, May 3, and November 1, 2002). The elevated beryllium concentration and its close relationship to the depth of color penetration in these sapphires demonstrated that diffusion of Be into the crystal lattice of

TABLE 1. Properties of unheated and heat-treated amber.^a

Sample no.	Color	Long-wave UV fluorescence	R.I.	Comments
1	Pale yellow	Dull greenish yellow	1.54	Unheated reference sample
2	Pale orangy yellow	Yellowish orange	1.54–1.55	Double lines in the refractometer
3	Yellow-orange	Orange	1.54–1.56	Range in R.I. values obtained only when sample was rotated
4	Orange	Bright orange	1.54–1.59	More than 10 lines seen in the refractometer within this range; range in R.I. values obtained only when sample was rotated
5	Brownish orange	Brownish orange	1.60	Abundant tiny gas bubbles present just below the surface
6	Dark brown	Dark orange	1.62	Abundant tiny gas bubbles present just below the surface

^a Note that specific gravity ranged from 1.07 to 1.09, with no systematic variation according to color. Samples were heated in a nitrogen atmosphere.



Figure 30. With increasing temperature and heating time, the color of these amber samples (left to right, samples 1 to 6 in table 1) changed from yellow to orange to dark brown. The reference sample on the far left has not been heat treated. Samples 4 and 6 were cut in half for testing purposes. The samples range from 3.2 to 13.8 ct. Photo by Morley Chang.

the sapphire could be the main cause of the color change. As part of our ongoing research into this treatment, GIA has had additional chemical analyses performed. These new data have not only supplemented the information we had on this treatment, but they also have led us to reevaluate some of the earlier analyses.

Due to insufficient calibration standards, a large uncertainty was associated with the previously published concentrations of Fe and Be obtained through SIMS analysis (see www.gia.edu/pdfs/table2.pdf and Spring 2002 Gem News International, pp. 86–90). As we indicated at that time, the uncertainty of the Be concentration, for example, could be as high as ±200%. This was because the SIMS facility that provided the analyses did not have established corundum standards for these elements. In our efforts to improve the accuracy of analysis, we worked with the facility to create new corundum standards for Fe and Be by means of ion implantation. Using the new standards, we

Figure 31. More than 10 lines were visible in the refractometer between 1.54 and 1.59 for heat-treated amber sample 4. Photo by Morley Chang.





Figure 32. These sapphires were treated by Be diffusion. Shown are a yellow (sample 45035, 1.22 ct) and an orangy red sapphire (sample 45033, 1.54 ct pear shape) that were treated in Thailand, as well as an orange sapphire (sample 48717, 0.86 ct) and ruby (sample 48878, 2.78 ct) that were treated by an unknown source. See table 2 for the chemical analyses of these samples. Photo by Elizabeth Schrader.

recalculated the concentration of Fe and Be in the previous analyses. We also reanalyzed several of the samples we had tested earlier (see table 2). Note that, in a few samples, Ti concentrations are not available because of technical problems with the original analyses. Also, Si concentrations were measured in some of our most recent analyses only.

The recalculated SIMS data indicate that although the concentrations of Fe and Be have changed, the relative relationships between the values remain the same; that is, in those sapphires that show clear color zonation from rim to center, the abundance of Be in the rim is still approximately 10 times greater than in the center. An analysis of the original (not repolished) surface of treated orange sapphire no. 48413 revealed that the Be concentration was as high as 99 parts per million (ppm). In some samples, Be had diffused through the entire crystal, so no color zoning was observed. We also conducted additional before-and-after experiments (samples 45493–45494) for which, as done previously for samples 45002 and 45031, we had an untreated natural pink sapphire from Madagascar sawn in half, and then had one half treated in Thailand using the same method as for the other treated sapphires. In both sets of samples, the treated halves showed a greater Be concentration than the untreated halves. Compared to the other elements analyzed, the Be concentrations showed the largest and most consistent changes caused by the treatment. The much smaller variations in the other elements could be due to chemical heterogeneity within the samples on a micrometer scale, the high-temperature diffusion process itself, and/or surface contamination introduced in the sample preparation for analysis.

Recent experiments have demonstrated that diffusion of about 10 ppm Be could create strong coloration in very pure originally colorless synthetic corundum (J. L. Emmett, pers. comm., 2002). We have also seen that the lattice diffusion of Be may not necessarily lead to color change in all natural sapphires. For example, a significant concentration of Be (11 ppm) was detected at the rim of one pink sapphire (sample 45082) that showed no apparent change in color after the treatment. In addition, as reported earlier, high concentrations of Be (recalculated to 73–113 ppm) were detected in a crucible we obtained in Thailand that had been used for the treatment.

The Be concentrations in natural, untreated corundum samples that we have analyzed were typically below 1.0 ppm. In most cases, diffusion of trace amounts of Be into the lattice of a corundum sample at high temperature significantly changed its color appearance. To date, we have seen end products that are yellow, orange, orangy red, or even red, depending on the properties of the original corundum and the conditions of the treatment.

On the basis of all these data and observations, we believe that our previously published findings and conclusions about the importance of Be diffusion in this new sapphire treatment process continue to be valid.

Wuyi Wang (wuyi.wang@gia.edu) and Barak Green
GIA Gem Trade Laboratory, New York and Carlsbad

Orange topaz with synthetic hematite coating. Recently, the SSEF Swiss Gemmological Institute received for testing two bright orange stones that were represented as topaz. A 6.97 ct stone was donated by Peter Groenenboom of the Amsterdams Edelsteen Laboratorium in Arnhem (Netherlands), and a 2.95 ct topaz (figure 33) was submitted by another client; both parties reported that such stones have been offered recently in Nigeria. The following gemological properties, obtained on both stones, confirmed that they were topaz: biaxial, R.I.—1.610–1.619, birefringence—0.009, S.G.—3.53, and inert to long- and short-wave UV radiation. However, their bright orange color, which is comparable to spessartine garnet, is unusual for topaz.

Microscopic examination of both stones revealed a bluish green iridescence on the pavilion facets. Careful inspection using brightfield illumination also showed small, colorless chips along the pavilion facet edges (figure 34) and some colorless scratches on the pavilion facets. These features indicated the presence of a coating. Pink, orange, and red coatings on topaz have been attributed to a sputter-coating process (see Summer 1998 Gem News, pp. 143–144); the color layers deposited by that process could easily be scratched and removed.

However, the coating on these stones could not be scratched with a needle. This is the first time that orange-coated topaz with a hard and rather stable coating has been reported. In addition, the spotty appearance typical of sputter coatings was not observed on these two stones.

EDXRF chemical analyses of the pavilion surfaces of

TABLE 2. Trace-element composition of corundum and a crucible determined by SIMS (in ppm weight).^a

Sample	Color	Color zonation	Analytical position	Na	Mg	K	Ca	Ti	Cr	Fe	Ga	Si	Be	Description
39402	Orange	Yes	Rim	0.04	132	0.05	1.55	na	975	1831	89.8	na	6.41	Treated in Thailand; ground and polished through the center
			Midpoint	0.06	128	0.04	1.26	na	797	1409	59.7	na	0.61	
	Pink		Center	0.04	92.0	0.02	0.81	na	664	1276	49.9	na	0.62	
39403	Orange	Yes	Rim	0.37	126	0.56	1.80	123	333	1697	111	na	10.6	Treated in Thailand; ground and polished through the center
	Pink		Center	0.02	129	0.06	1.65	126	330	1714	114	na	0.59	
49185	Orange	Yes	Rim	0.47	151	0.36	3.03	183	157	863	67.9	78.6	6.99	Treated in Thailand; ground and polished through the center
	Pink		Center	0.09	150	0.05	2.73	170	142	803	61.6	52.4	0.68	
39404	Orange	Yes	Rim	3.46	146	4.24	7.98	na	697	2062	137	na	10.5	Treated in Thailand; ground and polished through the center
			Midpoint	0.84	97.8	1.35	1.90	na	473	1613	95.1	na	0.60	
	Pink		Center	0.59	72.3	0.74	1.18	na	333	1179	57.2	na	0.62	
45033	Orangy red	No	Rim	0.24	93.3	0.27	1.10	na	1798	2958	66.5	na	8.44	Treated in Thailand; ground and polished through the center
	Orangy red		Center	0.31	90.9	0.35	0.95	na	1809	2882	64.6	na	7.21	
45032	Orange	No	Rim	0.58	106	1.18	2.18	na	1705	2107	123	na	6.78	Treated in Thailand; ground and polished through the center
	Orange		Center	1.80	96.6	4.75	1.50	na	1363	1660	82.9	na	10.8	
48430	Orange	Yes	Surface	0.06	56.7	0.11	0.71	62.8	379	2312	121	na	7.92	Unknown source
48413	Orange	Yes	Surface	6.37	180	3.78	5.57	513	312	429	97.7	na	99.0	Unknown source, treated stone; not repolished
48717	Orange	Yes	Surface	0.65	50.8	0.85	0.73	56.4	244	1320	112	60.0	12.2	Unknown source
48882	Orange	Yes	Surface	0.05	115	0.08	0.95	187	138	362	27.3	11.9	6.45	Unknown source
45493	Orange	Yes	Surface	2.48	159	1.28	2.66	211	1987	315	115	na	7.93	Half treated in Thailand; repolished
45494	Pink	No	Surface	0.70	198	0.23	2.70	282	2361	430	174	na	0.64	Untreated half
45002	Orange	Yes	Surface	0.60	151	0.91	1.86	na	1121.6	509	125	na	5.29	Half treated in Thailand; repolished
45031	Pink	No	Surface	0.04	125	0.04	1.22	na	744	420	77.4	na	0.53	Untreated half
45082	Pink	No	Rim	0.45	256	0.25	3.49	359	2702	955	176	na	11.0	Treated in Thailand; ground and polished through the center
	Pink		Center	0.95	232	0.77	3.69	327	2666	917	169	na	0.62	
	Pink		Center	0.43	228	0.41	3.31	328	2661	909	166	na	0.61	
45035	Yellow	No	Rim	0.07	30.1	0.09	0.44	102	10.5	9493	188	na	9.05	Treated in Thailand; ground and polished through the center
	Yellow		Center	0.03	29.3	0.07	0.42	54.0	23.3	9199	187	na	7.19	
45490	Yellow	No	Rim	0.04	6.18	0.02	0.22	46.9	9.94	4069	115	na	10.8	Treated in Thailand; ground and polished through the center
	Yellow		Center	0.03	14.1	0.02	0.24	37.1	10.0	4122	160	na	1.38	
45491	Yellow	Yes	Rim	0.19	66.2	0.06	1.16	20.1	3.71	683	93.9	na	9.52	Treated in Thailand; ground and polished through the center
	Pale yellow		Center	0.14	57.6	0.03	0.80	14.1	0.55	531	66.0	na	0.82	
48415	Red	Yes	Surface	0.49	75.5	0.46	1.05	110	10387	6613	182	na	11.0	Unknown source
48878	Red	Yes	Surface	0.13	1009	0.15	11.0	1231	8380	4766	109	220	8.71	Unknown source
45100	Crucible		White inner area	66.9	943	3.33	675	na	289	1154	83.8	na	113	Crucible that had been used for this type of treatment in Thailand
	Crucible		Blue inner area	2.59	736	1.20	35.9	na	264	951	75.6	na	73.2	
	Crucible		Convex outer surface	117	2217	9.71	702	na	138	858	75.9	na	105	

^a Yellow rows correspond to previous analyses that were recalculated against new Be and Fe standards. Analyses highlighted in blue were obtained more recently, with all elements calibrated against new standards. Rows in darker yellow and darker blue refer to samples that were analyzed both before and after treatment. Abbreviation: na=not analyzed.

both samples revealed high concentrations of iron. Raman spectra of the coated surfaces revealed distinct hematite peaks, in addition to peaks corresponding to the underlying

topaz. It appears, then, that the orange color of these samples is derived from a thin coating of microcrystalline hematite applied to the pavilion surfaces. To our knowl-



Figure 33. The orange color of this 2.95 ct topaz is caused by a thin coating of synthetic hematite applied to the pavilion. Photo by Michael S. Krzemnicki; © SSEF Swiss Gemmological Institute.

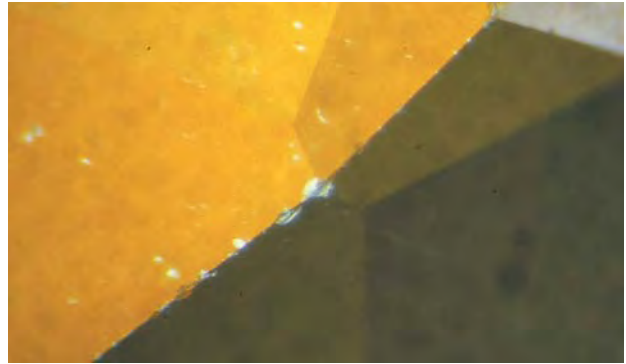

Figure 34. Minute colorless chips are visible along the edges of the pavilion facets on this coated topaz. Photomicrograph by Michael S. Krzemnicki, magnified 35x; © SSEF Swiss Gemmological Institute.

edge, this is the first time that synthetic hematite has been used as a coating on a gemstone.

This investigation reinforces the importance of carefully inspecting faceted gems from all angles. Analysis of only the crown of these stones with standard or advanced techniques would not have revealed their true nature.

Although the surface coating of topaz has been known for quite some time, such stones are often sold as “diffusion” treated. The two coated samples reported here showed no evidence of diffusion into the stone.

Michael S. Krzemnicki (*gemlab@ssef.ch*)
SEEF Swiss Gemmological Institute

CONFERENCE REPORTS

Diamond presentations at the annual Australian Diamond Conference. Attendance at the annual Australian Diamond Conference, held in Perth on December 2–3, 2002, was just over 200, down from last year's 240 (see Winter 2001 Gem News, pp. 333–334). There were 26 presentations and a concluding panel discussion. The few non-Australian presenters included **Susan Shabangu** of the Ministry of Minerals and Energy, Johannesburg, South Africa, and **Nirupa Bhatt** of Rio Tinto Diamonds, Mumbai, India. Ms. Shabangu emphasized that the new South African mining law will give the indigenous people more control over mining their resources without nationalizing the industry. Ms. Bhatt discussed the enormous growth of the Indian diamond cutting and polishing industry, which now employs over one million people. Its success is due to the abundance of low-value rough produced by Australia's Argyle mine, the low cost of competent labor in India, and the marketing efforts of the Indo-Argyle Diamond Council.

Following the opening address by **Ewen Tyler** of Striker Resources, Perth, **John Hughes** of De Beers Consolidated Mines, Johannesburg, said that De Beers was committed to continuing diamond prospecting in Australia where, in 2002, it spent 8% of its global US\$40 million exploration budget. **Carl Pearson** of Econunit, London, discussed the importance of branding to promote diamonds and stated

that the diamond industry must increase its advertising budget, which is approximately one tenth of the ad budgets for other luxury goods such as watches. **Mike Mitchell** of Rio Tinto Diamonds, Perth, emphasized complete accountability “from cradle to grave” in all aspects of prospecting and mine development, awareness of socio-economic and environmental impacts on the region and its indigenous people, and involvement in downstream marketing.

Many speakers reported on the results and progress of their respective companies, the most important being **Miles Kennedy**, **David Jones**, **Nick Yiannopoulos**, and **Peter Danchin** of Kimberley Diamond Co., Perth, who were happy to announce that the Ellendale diamond mine has a higher grade (as reflected by current mining activities of 15 ct/100 tonnes) and value per carat (as indicated by the latest sales in Antwerp of US\$155/ct) than predicted by the feasibility study (see, e.g., Fall 2002 Gem News, pp. 258–259). **Max Cozijn** and **Linda Tompkins** of Elkedra Diamonds, Perth, reported on the discovery of numerous chromites of possible kimberlitic origin in Australia's Northern Territory. According to a subsequent company news release, the loam samples from which many of these chromites were recovered occurred in a 2.5-km-diameter ring-shaped structure. **Karl Simich** of Namakwa Diamonds, Perth, presented results of their bulk sampling of uplifted beaches on the coast of Namaqualand, South Africa; the production was better than the expected economic grade of 10 carats per 100 tonnes. **Phil Crab** of Thundelarra Exploration, Perth, announced the discovery of four new small kimberlite pipes, south of the large 20 ha (noneconomic) Aries pipe in the Kimberley Plateau of Western Australia. **Tom Reddcliffe** of Striker Resources, Perth, reported an unexpectedly high grade of 225 carats per 100 tonnes from a 183 tonne bulk sample taken from the Seppelt 2 pipe, located in the northern part of the Kimberley Plateau of Western Australia. Plans to drill for a deeply buried (up to 280 m) large kimberlite pipe beneath the Springfield Basin in South Australia were discussed by **Kevin Wills** of Flinders Diamonds, Perth.

Several speakers gave presentations on new exploration methods. **Richard Russell**, consulting geomorphologist to

Mt. Burgess Mining, Perth, showed that ground gravity methods had a greater success in outlining kimberlite pipes buried under Kalahari sands in northeast Namibia than ground magnetic surveys or other geophysical methods. **Stefan Schwank** of Bauer Maschinen, based in Schrobenthausen, Germany, illustrated how large-diameter (up to 3 m; see, e.g., figure 35) drill rigs are now being used to: (1) evaluate dump material at kimberlite mines, such as Koffiefontein and Jagersfontein in South Africa; (2) sample kimberlite at the Ellendale mine in Western Australia; and (3) recover ocean floor sediments off the coast of Namibia. He also described their potential for the actual mining of kimberlite from barges in deep open pits that have become flooded with water. **Phil Harman** of Gravity Capital, Melbourne, discussed the advantages of BHP's new Falcon™ airborne gravity method in finding kimberlite pipes. Gravity Capital will apply this method at their joint-venture properties, interpret the data, select prospective ground, and drill the targets to evaluate the prospects for a 50–50 equity. **Nick Lockett**, diamond exploration consultant in Perth, discussed the interpretation of satellite images and aerial photographs for locating primary diamond deposits in lateritic and glaciated terrain. **Kevin Dardis** of Fluor Australia, Perth, spoke about bringing online the new Combined Treatment Plant of De Beers mines in Kimberley, South Africa, which was designed especially to treat clay-rich material from old waste dumps and from the Dutoitspan mine.

Other presentations included one by **Tracey Rogers** of Australia's Northern Territory geological survey, based in Darwin, about developing geoscientific datasets for diamond explorers that can be downloaded free of charge; and by **Garry Holloway** of Diamond-Cut Inc., Melbourne, who emphasized that the "fourth C," cut, is the "Cinderella of the valuing process" and an increasingly important factor in the retail trade. He described a simple, small instrument that jewelry stores can use to help illustrate cut quality for their customers.

The mood of the conference attendees was subdued, but guardedly optimistic that the economic downturn was over and conditions were slowly improving. This is demonstrated by the current high number of exploration samples submitted to Australian laboratories for indicator mineral processing.

A. J. A. "Bram" Janse (*archon@space.net.au*)
Archon Exploration Pty. Ltd.
Carine, Western Australia

Antwerp Diamond Conference. On October 7–8, 2002, some 400 participants from major diamond producing, processing, and consuming nations assembled in Antwerp for a conference on international diamond policies and strategies. Speakers included key government and mining company executives from South Africa, Namibia, Botswana, Australia, Canada, and Russia; industry bankers; and diamond manufacturers. In addition, the president of Botswana, Festus Mogae, and former U.S. vice-president Al Gore addressed the gathering.



Figure 35. Shown at an on-shore marine diamond deposit in Namibia, this 100-ton rotary drilling rig employs a 2.5-m-diameter bucket, which has a capacity of 5 m³ or 10 tons and can reach depths to 115 m. Courtesy of Bauer Maschinen.

The program, moderated by Chaim Even-Zohar (Tacy Ltd., Tel Aviv, Israel) focused on four main challenges of marketing new diamond production:

1. Expansion of production from new sources: This will inevitably lead to greater competition among producers and possible excess of supply over demand.
2. Advancing technology: In diamond exploration, more effective exploration methods will accelerate new discoveries. In diamond processing, new treatments will be developed to improve a diamond's appearance.
3. Greater scrutiny by the public, government, news media, and bankers: This includes an awareness of conflict diamonds, international finance, and a greater need to know the backgrounds of business partners.
4. Increased marketing and branding: This will be necessary to expand sales of diamond jewelry and to maintain quality assurance.

On the first two points, mining company executives discussed ongoing exploration efforts that will likely increase diamond production in the coming decades. **Gordon Gilchrist** of Rio Tinto, London, predicted that the world supply of rough diamonds will increase from US\$7.5 billion in 2002 to \$9 billion in 2007. **Robert Boyd** of Ashton Mining

Co., Vancouver, noted that mining companies are spending \$200 million annually on diamond exploration, 41% of this in North America. **Valery Kalitin** of Alrosa, Moscow, reported that his company has identified a number of new diamondiferous areas in Russia and will begin sampling next year. Offshore of Namibia, Namdeb (a joint venture between De Beers and the Namibian government) and Namco are using new technologies to extract diamonds from the seabed much more efficiently. **Greg Walker** of Namco, Windhoek, Namibia, said that as many as 3 billion carats could be lying offshore, scattered along the 1,400-mile-long Namibian coastline.

The conflict diamond issue has generated negative press and attention from Non-Governmental Organizations over the past two years. De Beers Chairman **Nicky Oppenheimer** congratulated the diamond industry on its efforts to stop such diamonds from entering the legitimate trade; however, the reputation of the industry is still at stake. He noted that diamonds can be a major contributing force to the economies of producing countries, if the governments offer a "secure, transparent, and predictable legislative environment." He singled out Botswana as an example of a nation that has used its diamond wealth to create prosperity. Botswana president **Festus Mogae** elaborated, telling the audience that his country's prosperity is rooted in the rule of law, and stating that his government is committed to the Kimberley Process of certifying the origins of rough diamonds. **Al Gore**, who addressed the closing dinner, declared that the conflict diamond issue was "largely a thing of the past" and congratulated the industry on its efforts to greatly reduce trade in such diamonds.

Governments are also demanding greater financial accountability from the industry, in the wake of allegations that money launderers and terrorists have used gems to finance their activities. **Paul Goris** of the Antwerp Diamond Bank, Belgium, stressed that bankers will more closely monitor their clients' businesses, requiring increased disclosure about their partners. **Jim Antoine** of the Government of the Northwest Territories, Canada, noted that diamond mining companies have a responsibility to protect the environments in which they operate and to ensure that development of natural resources benefits the people living in affected areas.

Most of the speakers agreed that diamond branding was still a new and largely untried concept. **Gareth Penny** of De Beers, London, told the audience that branding need not be limited to a product, but could also include service and the store selling the product. A brand, he said, must mean something to the consumer in terms of quality assurance, trust, and service. It must also be based on consumer needs. He showed how the three-stone ring promotion redressed an old concept into a new idea and captured 1% of the diamond jewelry market in 2001 and 3%–4% in 2002—with a goal of attaining 10% in the future.

Other producers focused on increasing diamond sales through strategic partnerships. Aber Resources, for example, entered into an equity arrangement with Tiffany & Co., because a significant percentage of production from

Diavik is very high quality. **Matt Manson** of Aber, Toronto, said that his company believes that growth of brands will drive future demand in the diamond market, but also that its best strategy is to partner with existing diamond jewelry and luxury goods houses.

China is the fastest growing retail diamond jewelry market. **Du Gong-pu** of the Shanghai Diamond Exchange, Shanghai, reported that in June 2002, the Chinese government enacted a new import taxation policy that removes all taxes and duties on polished and rough diamonds except at the retail sales level. Finished diamond jewelry imports are still subject to a tariff of 30%–35% plus a 17% value-added tax. The aim, he said, is to provide business opportunities for major diamond manufacturing operations to produce diamonds and diamond jewelry for domestic sale and re-export. Diamond polishing and jewelry manufacturing operations are concentrated in three areas: Guangdong Province, with 12,000 workers; Shandong Province, with 5,000 workers; and Shanghai, with 200 workers. Monthly wages average \$100 to \$200. In 2001, China imported 3.28 million carats of rough diamonds, valued at \$623 million.

*Russell Shor (russell.shor@gia.edu)
GIA, Carlsbad*

Antwerp Gem Conference. On November 10–11, 2002, more than 100 people attended this conference, organized by the HRD—Institute of Gemmology. The keynote speaker, **Joanna Hardy** of Sotheby's Jewellery Department in London, offered pointers for evaluating estate jewelry, including the paramount importance of provenance. **Dr. Jeff Van Royen**, of the Antwerp Diamond High Council, reviewed the development and identification of HPHT-treated diamonds, and reported that a Russian-manufactured "BARS" apparatus has been installed near Antwerp for use by HRD researchers. **Dr. A. H. Rankin** of Kingston University, London, described how Raman analysis and LA-ICP-MS can be used to "fingerprint" gems as to their locality or natural/synthetic origin. LA-ICP-MS is a very sensitive technique, but it is also expensive and current databases are lacking. **Dr. Lore Kiefert** of the SSEF Swiss Gemmological Institute, Basel, reviewed the fillers used in emerald and ruby, which can be identified with magnification or (for emeralds) with IR spectroscopy or Raman analysis.

Dr. Emmanuel Fritsch of the University of Nantes, France, reported on various aspects of opal structure, including the differences between opals with and without play-of-color; the latter tend to have the most organized structure and the most perfect "spheres" of silica. **Vincent de Jaegher**, of Vincent de Jaegher S.A. in Verviers, Belgium, reviewed several methods of pearl identification, including the use of X-rays (to separate natural from cultured pearls), high-power magnification (i.e., 100×–200×, to separate genuine products from imitations), UV fluorescence (to identify bleaching), and SEM (to help identify treated black and polished pearls). **Dr. Dirk Van Dyke** of the University of Antwerp explained the usefulness of (nondestructive) X-ray microtomography

in observing inclusions and fissures in diamonds to help with cutting. **John I. Koivula** of the GIA Gem Trade Laboratory in Carlsbad concluded the conference with a description of the special tools (e.g., fiber-optic illuminators and various filters such as the first-order red compensator) and techniques (e.g., shadowing) he uses for effective gemological photomicrography.

Alice S. Keller (akeller@gia.edu) and
John I. Koivula, GIA Carlsbad

ANNOUNCEMENTS

Beryllium: A known carcinogen. The National Institute of Environmental Health Services published the 10th edition of its biennial Report on Carcinogens in December 2002. Beryllium was upgraded from a "reasonably anticipated" to a "known" human carcinogen, and jewelers were among the workers listed who should take precautions to avoid exposure to beryllium-containing dust. To see the report, visit <http://ehp.niehs.nih.gov/roc/toc10.html>.

Conferences

PDAC 2003. The Prospectors and Developers Association of Canada convention will take place March 9–12 in Toronto. Diamonds will be featured in the technical program and reviewed in a "Commodities and Market Outlook" session. A pre-meeting short course on diamond exploration using kimberlite indicator minerals will be held March 8. Visit www.pdac.ca/pdac/conv, phone 416-362-1969, fax 416-362-0101, or e-mail info@pdac.ca.

Basel 2003. The World Watch, Clock, and Jewellery Show will be held April 3–10 in Basel, Switzerland. GIA will host GemFest Basel 2003 from 4:00 to 6:00 p.m. Saturday, April 5. Open to the public, it will highlight trends in fancy-color diamonds and present the latest discoveries from the GIA Gem Trade Laboratory. During the show, *Gems & Gemology* editor-in-chief Alice Keller will be available at the GIA Booth in Hall 2, Stand W23. Visit www.baselshow.com or call 800-357-5570.

Moscow gemology colloquium. The 6th International Conference *New Ideas in Earth Sciences* will take place April 8–22, 2003, in Moscow, and will feature a section on gemology. Contact GIA Moscow at gigia@rol.ru, 70-95-433-5566 (phone), or 70-95-438-1504 (fax).

Gems and industrial minerals. The 39th Annual Conference on the Geology of Industrial Minerals will occur May 18–24, 2003, in Reno, Nevada. Included in the program will be the session "Gemstones and Mineral Collectibles." Visit www.nbmj.unr.edu/imf or e-mail tgarside@unr.edu.

GAC-MAC-SEG meeting. The Geological Association of Canada, Mineralogical Association of Canada, and Society of Economic Geologists will host this large geosciences conference May 25–28, 2003, in Vancouver, Canada.

Special sessions on gem materials and Canadian diamonds will be offered. Visit www.vancouver2003.com, phone 604-681-5226, fax 604-681-2503, or e-mail vancouver2003@nrca.gc.ca.

Maine pegmatite workshop. Gem-bearing granitic pegmatites will be included in field studies from May 31 to June 2, 2003 that will be offered by pegmatite experts from the University of New Orleans and a local geologist and pegmatite miner. Visit <http://homepage.mac.com/rasprague/PegShop> or e-mail rasprague@mac.com.

Kimberlite conference. The 8th International Kimberlite Conference will take place June 22–27, 2003, in Victoria, Canada. Topics will cover kimberlite geology and economics, diamonds, target area selection, and diamond exploration. Visit www.venuewest.com/8ikc, phone 604-681-5226, fax 604-681-2503, or e-mail 8ikc@venuewest.com.

IN MEMORIAM

Prof. Dr. Pieter C. Zwaan, 1928–2002. *Gems & Gemology* author and noted gemologist P. C. Zwaan passed away November 7, 2002. Dr. Zwaan was awarded a Ph.D. in geology from the University of Leiden, The Netherlands, in 1955. At the National Museum of Natural History (formerly National Museum of Geology and Mineralogy) in Leiden, he acted as both mineral curator (1951–1993) and director (1979–1988). For several years, he was also a gemology instructor for the FGA diploma course at the School of Gold- and Silversmiths in Schoonhoven, the Netherlands, and a professor of gemology at the University of Leiden. For more than four decades, he directed the Netherlands Gemmological Laboratory in Leiden. He was an invited speaker at many international geological and gemological conferences, and led numerous field trips to gem localities in Asia, Brazil, and South Africa. He authored 149 articles on mineralogy and/or gemology, including two articles on Sri Lanka's gems in the Summer 1982 (pp. 62–71) and Winter 1996 (pp. 262–269) issues of *G&G*.

ERRATUM

In the Spring 2002 Dirlam et al. article on liddicoatite (pp. 28–53), there were some inaccuracies in references to Russian publications. First, the reference listed as Shmakin and Makagon (1999) should have been shown as:

Zagorsky V.Ye., Peretyazhko I.S., Shmakin B.M. (1999) *Miarolitic Pegmatites*. Volume 3 of B. M. Shmakin and V. M. Makagon, Eds., *Granitic Pegmatites*, Nauka—Siberian Publishing Firm RAS, Novosibirsk, Russia.

Also, in the reference to "Zagorsky et al. (1989)," the correct spellings of the author names are *Zagorsky* and *Shiryayeva*. We thank Dr. Victor Ye. Zagorsky of the Siberian Branch of the Russian Academy of Sciences, Irkutsk, Russia, for bringing these errors to our attention.

EDITORS

Susan B. Johnson
Jana E. Miyahira-Smith

The Master Jewelers

By A. Kenneth Snowman, Ed., 262 pp., illus., publ. by Thames & Hudson Inc., New York, 2002. US\$29.95*

This book showcases the artists' paradise that blossomed across Europe from Paris to St. Petersburg during the mid-to-late 19th century and the bejeweled splendors created in the 20th century. As impressionist painters splashed canvases with flashes of light extracted from oils, a remarkable group of master jewelers that included Vever and Lalique gave birth to timeless jeweled art.

Fifteen extraordinary jewelers are portrayed in as many chapters, each written by an expert and, in the case of Boucheron, the artist's descendant. Despite differences in style and emphasis, the authors create historical vignettes that evoke the tenor of the times, framing the creations each master jeweler brought to life in the context of influential, if unseen, forces.

Along with the three noted above, the maestros include Castellani and Giuliano, Fontenay, Hancock, Falize, Fabergé, Tillander, Fouquet, Tiffany, Cartier, Van Cleef & Arpels, Verdura, and Bulgari. The text is replete with anecdotes and remarkable details that capture the artists' struggles and competitions against a backdrop of socio-cultural and political change. Readers may marvel at the image of a Punjabi Maharajah arriving at Boucheron's Paris store in 1927 with 40 servants, 20 dancing girls, and six caskets of diamonds, emeralds, pearls, rubies, and sapphires of incomparable beauty. The author gives a breathtaking description of this bounty, destined for transformation into tiaras, aigrettes, belts, and necklaces.

Supporting the text are exceptional illustrations—337 in all, 251 in color—exhibiting the works themselves inter-

persed with original sketches of designs and early photographs of the houses. Readers are treated to glimpses of rarely seen pieces from private collections, many showcased in their original boxes, all magnificently captured by crisp photographs that allow each piece to whisper or shout for itself.

The publisher continues its tradition of quality production with the use of sturdy, fine paper and superb printing. The large (12 × 9 inch) soft-covered format allows readers a near-tactile experience with jewels and *objets d'art* of staggering artistic achievement.

Uneven pacing slightly mars this multi-authored text. Occasional editorial lapses allow descent into extraneous detail, and an obtrusive plug for one house's perfume may catch readers by surprise. In addition, while authors such as Ralph Esmerian may need no introduction, the absence of author biosketches leaves the curious reader unsatisfied. The index is serviceable though incomplete.

Still, these minor flaws hardly diminish the monumental achievement of this historical and artistic *tour de force*. Serious gemologists, art and jewelry historians, students of decorative arts and fashion, appraisers, antique dealers, collectors, and curators will be awed by the tome's treasures and its celebration of enduring genius.

MATILDE PARENTE, G.G.
Rancho Mirage, California

20th Century Jewelry: The Complete Source Book

By John Peacock, 144 pp., illus., publ. by Thames & Hudson Inc., New York, 2002. US\$34.95*

This colorful, beautifully illustrated book depicts jewelry forms and fashion of the 20th century. It is divided into five parts, each covering two

decades. Within each 20-year period, the jewelry is categorized into "earrings," "rings," "brooches," and the like. Numbered line drawings follow each chapter, and accompanying legends identify the jewelry, its materials, the date and (for some) the jeweler who inspired the piece.

Mr. Peacock indicates that the book is directed toward the designer, student, enthusiast, and nonspecialist. Unfortunately, the author fails to grasp jewelry in the context of the 20th century, and the book contains a good deal of misinformation. The statement that diamond jewelry was never worn in the daytime until the 1980s is false. One need only look at fashion magazines of the 1950s to see diamonds and gemstones, set in yellow gold, adorning fashionable women prior to the cocktail hour.

Another example is a reference to the 1930s as having "more feminine jewelry," an assertion that negates the move toward modernism following the Depression. Indeed, the most feminine jewelry in history dates to the Edwardian era at the onset of the 20th century, and the book's most effective drawings depict those pieces. Least effective are illustrations from the 1930s. Static and flat, they reveal only half the story of late 1930s jewelry, which was asymmetrical, large, and bold.

By isolating the different types of jewelry, the book lacks continuity and flow. More importantly, there is no sense of cohesiveness regarding "the total jewelry style" of the decade. Last, the layout is cumbersome. Because the line drawings and legends are separated, one constantly finds oneself going back and forth.

The author, an accomplished fashion illustrator, falls short of producing a book for serious jewelry students. If anything, it is a rich compendium of illustrations for those who seek to cre-

ate reproductions, precisely because of the fine drawings.

JOYCE JONAS
*President Emeritus
American Society of Jewelry Historians*

Louis Comfort Tiffany at Tiffany & Co.

*By John Loring, 255 pp., illus., publ.
by Harry N. Abrams, New York,
2002. US\$60.00**

John Loring, the design director of Tiffany & Co., has invited us to examine Tiffany style and history through his several books. The latest, which discusses the life and inspirations of Louis Comfort Tiffany, is another fine example worthy of exploration.

In his introduction, Loring explains how the influence of Louis Comfort Tiffany became obscured in recent history. Even within Tiffany & Co. itself, his legacy was all but forgotten in the wake of new design visions of the 1940s and '50s. Not until the 1980s, during preparation for Tiffany & Co.'s 150th anniversary, was he acknowledged as a major force in the company's design direction during the early 20th century.

The son of company founder Charles Lewis Tiffany, Louis Comfort has been noted mainly for his innovative glass designs, which are widely collected today. However, he was also prolific in the use of bronze, ceramics, mosaics, and enamels for desk sets, jewelry boxes, clocks, and other decorative objects. His jewelry designs were deeply influenced by silversmith

Edward C. Moore and gemologist George Frederick Kunz. Indeed, Kunz provided Tiffany's with gems unusual to the period, such as fire opal, Maine tourmaline, and demantoid garnet. All were used to great success.

The book is divided into chapters that specifically examine Louis Comfort Tiffany's jewels, enamels, glass, pottery, and other precious objects. It is lavishly illustrated with photographs and original design sketches, many from the Tiffany & Co. archives. Beautiful to look at and very interesting to read, this book is a welcome addition to the library of any lover of jewels or the decorative arts.

JANA E. MIYAHIRA-SMITH
*Gemological Institute of America
Carlsbad, California*

OTHER BOOKS RECEIVED

The Love of Stones. *By Tobias Hill, 396 pp., publ. by Picador USA, New York, 2001, US\$25.00.* This beautifully crafted novel combines action and human drama to tell the story of a spectacular 15th century jewel, The Three Brethren (a medieval clasp named for its three 70 ct spinels), that is destined for glory among the crown jewels of England.

British poet Tobias Hill's tale of lapidary intrigue unfolds around three characters, separated by centuries but all intimately bound to the elusive jewel. Using inventive parallel plots, Hill seamlessly transports readers from modern times to the 19th centu-

ry and earlier, offering glimpses of gem enthusiasts Jean-Baptiste Tavernier and the young Queen Victoria, among others, as the jewel changes ownership—and transforms the lives of those who possess it.

The book's present-day protagonist is gem dealer Katharine Sterne, who is consumed by her quest to find the Brethren. Traveling alone, Sterne is undeterred by peril and a host of uncooperative characters, as she forges ahead on her low-budget quest across Turkey, then to London, and eventually to a remote Japanese village. Hill links Katharine's adventures to the tale of two brothers, Salman, an apprenticed lapidary, and Daniel, a gem merchant. The brothers flee their wretched lives in 19th century Baghdad to seek fortunes in pre-industrial London, a city polarized by extremes of rags and riches.

Their struggles lend a palpable humanity to this novel's many plot twists, as Hill transports readers from one century to another. Circles and riddles converge as civilizations, rulers, and commoners fade in and out. Jewels—and the love of them—reflect, refract, circle back and endure.

This novel is a refreshing break from the frequently overwrought heist-and-caper fiction that features gems. Though some of Hill's off-the-mark gemological musings may prompt knowing readers to blink, his writing is richly evocative. The riveting narrative will appeal to all readers who share a passion for stones, as well as those who enjoy fast-paced historical drama.

MATILDE PARENTE, G.G.

2002 MANUSCRIPT REVIEWERS

GEMS & GEMOLOGY requires that all articles undergo a peer review process in which each manuscript is evaluated by at least three experts in the field. This process is vital to the accuracy and readability of the published article, but it is also time consuming for the reviewer. Because members of our Editorial Review Board cannot have expertise in every area, we sometimes call on others in our community to share their intellect and insight. In addition to the members of our Editorial Review Board, we extend a heartfelt thanks to the following individuals who reviewed manuscripts for *G&G* in 2002:

Mr. Shigeru Akamatsu
Mr. Tom Chatham
Mr. Martin Cooper
Mr. Tom Cushman
Ms. Dona Dirlam
Ms. Nancy Dix
Ms. Patti Geolat
Mr. Ishaia Gol

Dr. Edward Grew
Mr. Eli Haas
Mr. Hertz Hasenfeld
Dr. Jaroslav Hyrsl
Dr. Joachim Karfunkel
Dr. Lore Kiefert
Mr. John Kim
Mr. Kevin Krajick

Mr. Bert Krashes
Mr. Nir Livnat
Dr. David London
Mr. Matt Manson
Mr. Terrence Meador
Dr. A. R. Miciak
Ms. Elise Misiorowski
Mr. Glenn Nord

Mr. Jeff Scovil
Dr. William Simmons
Dr. Ichiro Sunagawa
Harold & Erica Van Pelt
Dr. Christopher Welbourn
Mr. Robert Weldon
Mr. Alfred Woodill
Dr. Joachim Zang

EDITOR

A. A. Levinson
University of Calgary
Calgary, Alberta, Canada

REVIEW BOARD

Jo Ellen Cole
Vista, California

D. Darmour
GIA Gem Trade Laboratory, Carlsbad

Vladislav Dombrovskiy
GIA Gem Trade Laboratory, Carlsbad

R. A. Howie
Royal Holloway, University of London

Alethea Inns
GIA Gem Trade Laboratory, Carlsbad

Taijin Lu
GIA Research, Carlsbad

Wendi M. Mayerson
GIA Gem Trade Laboratory, New York

Kyaw Soe Moe
GIA Gem Trade Laboratory, Carlsbad

Keith A. Mychaluk
Calgary, Alberta, Canada

Joshua Sheby
GIA Gem Trade Laboratory, New York

Russell Shor
GIA, Carlsbad

Jana E. Miyahira-Smith
GIA Education, Carlsbad

Maha Tannous
GIA Gem Trade Laboratory, Carlsbad

Rolf Tatje
Duisburg University, Germany

Christina Taylor
GIA Gem Trade Laboratory, Carlsbad

Lila Taylor
Santa Cruz, California

Paige Tullios
GIA Gem Trade Laboratory, Carlsbad

Sharon Wakefield
Northwest Gem Lab, Boise, Idaho

Michelle Walden
GIA Gem Trade Laboratory, Carlsbad

COLORED STONES AND ORGANIC MATERIALS

Amber: The organic gemstone. J. B. Lambert and G. O. Poinar Jr., *Accounts of Chemical Research*, Vol. 35, No. 8, 2002, pp. 628–636.

Amber is a fossilized form of terpenoid plant resin, the sticky substance produced by plants all over the globe. Diterpenoid resins, produced by conifers and angiosperms, are prone to polymerization and are the predominant source of amber used for cultural purposes (including gems). Triterpenoid resins, produced by broad-leaved trees, are nonpolymerizing and used as varnish resins or for incense. This study applied solid-state ^{13}C nuclear magnetic resonance (NMR) spectroscopy to several hundred samples in order to characterize modern resins, fossil resins of known geological provenance, and archeological materials.

Diterpenoid and triterpenoid samples were distinguished on the basis of their ^{13}C NMR spectra, as were changes in spectra according to age, presumably as a result of polymerization or degradation. Four major groupings of fossil resins were recognized. Group A resins spanned the globe in Cretaceous time and relate to the modern genus *Agathis* in New Zealand and Australia. Group B resins were widespread in Tertiary times from India to North America but are not related to specific modern plants. Group C resins, the Baltic amber group, were localized in Europe in Tertiary time but do not correspond to modern genera. Group D resins are found in the Americas and Africa and are closely related to the modern genus *Hymenaea*. Thus, ^{13}C NMR spectra can be used to determine the general provenance of archeological materials provided a sufficient sample (>30 mg) and an extensive NMR spectra database are available. CT

This section is designed to provide as complete a record as practical of the recent literature on gems and gemology. Articles are selected for abstracting solely at the discretion of the section editor and his reviewers, and space limitations may require that we include only those articles that we feel will be of greatest interest to our readership.

Requests for reprints of articles abstracted must be addressed to the author or publisher of the original material.

The reviewer of each article is identified by his or her initials at the end of each abstract. Guest reviewers are identified by their full names. Opinions expressed in an abstract belong to the abstracter and in no way reflect the position of Gems & Gemology or GIA.

© 2002 Gemological Institute of America

A study of amber and copal samples using FT-Raman spectroscopy. R. H. Brody, H. G. M. Edwards, and A. M. Pollard, *Spectrochimica Acta*, Part A, Vol. 57, No. 6, 2001, pp. 1325–1338.

FT-Raman spectra were obtained from 28 amber and copal samples from various geographic sources (Poland, northern Germany, Prussia, England, Dominican Republic, East Africa, Mexico, Lebanon, Burma, and Borneo). The majority of the fossil resins could be related to modern resins containing diterpenoid components with predominantly labdane skeletons; only the sample from Borneo contained triterpenoid components. Differences in the spectra of samples containing diterpenoids relate to variations in sample maturity rather than geographic origin; however, the degree of maturation could be used in some cases as an indicator of possible geographic origin. The authors suggest that infrared spectroscopy is more useful than FT-Raman spectroscopy for the identification of the geographic sources of amber and copal. CT

Minerals explained 36. Turquoise. R. J. King, *Geology Today*, Vol. 18, No. 3, 2002, pp. 110–114.

Turquoise mining dates to 3200 BC in the Sinai Peninsula and 2100 BC in Persia (Iran). In the southwestern U.S., turquoise has been mined since about 200 BC. While its etymology is complicated, the name *turquoise* was probably derived from the 16th century French *turquois* for Turkish, as Persian turquoise (the finest quality) was brought to Europe after having been purchased by Venetian merchants in Turkish bazaars.

Turquoise is essentially a supergene mineral produced by the percolation of meteoric water through aluminum-rich rocks in the presence of copper, usually in an arid environment. Turquoise is blue in the presence of copper without iron; the presence of iron adds a greenish hue. Dehydration leads to a loss of color, but, in general, turquoise is considered a stable mineral. Minerals commonly mistaken for turquoise include chrysocolla, faustite, lazulite, malachite, and variscite. Widespread falsification and stabilization of turquoise, primarily because of a shortage of good gem material, have prompted New Mexico to regulate the nomenclature according to the terms *natural*, *stabilized*, *heated*, *reconstructed*, and *imitation*. Protecting turquoise from the effects of soap, detergent, body oils, heat, and prolonged exposure to light will insure its well-being. CT

Spectroscopy of natural silica-rich glasses. E. Faulques, E. Fritsch, and M. Ostroumov, *Journal of Mineralogical and Petrological Sciences (Japan)*, Vol. 96, No. 3, 2001, pp. 120–128.

Eleven silica-rich natural glasses (e.g., obsidian, Libyan Desert glass [LDG], Darwin glass [DG], and tektites such as moldavite and australite) and one synthetic silica glass were studied by three spectroscopic techniques (optical, infrared, and Raman) to determine their structural and

related characteristics.

The IR spectra are strongly dependent on silica (SiO₂) content. Thus, a doublet at 1259 and 1122 cm⁻¹ in LDG (95% SiO₂) is shifted to 1220 and 1097 cm⁻¹ in a tektite (73% SiO₂). Other IR absorptions suggest that LDG contains more water than moldavite. Raman spectra of LDG, DG, and the synthetic glass are almost identical (showing a typical doublet at 490–440 cm⁻¹), whereas tektites and obsidian have similar broad Raman bands centered around 1600 and 1000 cm⁻¹ due to substitution of metals for silicon. Micro-Raman spectrometry techniques have identified gas bubbles (most of which are voids) and lechatelierite (naturally fused amorphous silica) in tektites, and small white inclusions of cristobalite in LDG. Optical (Vis/NIR) spectra of tektites show a strong absorption band at 1100 nm attributed to Fe²⁺. Obsidian and other glasses (except tektites) show sharp bands at 1380 and 2210–2250 nm, which represent water. KSM

DIAMONDS

An alternative interpretation of lower mantle mineral associations in diamonds. L. Liu, *Contributions to Mineralogy and Petrology*, Vol. 144, No. 1, 2002, pp. 16–21.

Diamonds containing inclusions of ferropericlase [(Mg, Fe)O] and certain silicates (e.g., Fe-containing enstatite [(Mg,Fe)SiO₃]) are generally believed to be derived from deep within the Earth's lower mantle (the zone 670–2,900 km below the surface). These inclusions are also believed to represent the nature of the rocks and minerals—for example, "(Mg,Fe)SiO₃-perovskite," the most abundant mineral phase in the lower mantle—and their reactions in that area of ultrahigh pressure. This has important implications for various mechanisms and processes operating within the Earth, among them, how diamonds reach the surface from such great depths.

On the basis of the observed ratio between ferropericlase and enstatite inclusions in diamonds, the FeO content of the ferropericlase, and a re-interpretation of published experimental data, the author concludes that most of these minerals entrapped in diamonds do not represent the nature of rocks in the *deep* parts of the lower mantle. Although these mineral inclusions do form in the lower mantle, they do so at shallower depths than previously estimated and by different reactions; the decomposition of ferromagnesite [(Mg,Fe)CO₃] to yield diamond + ferropericlase + oxygen is one that is considered particularly important. AAL

The current situation of China diamond processing industry. A. Zhang, *China Gems*, Vol. 10, No. 3, 2001, pp. 14–17.

"Made in China" is becoming synonymous with excellence in cutting and polishing diamonds. The Chinese

diamond-cutting industry has made tremendous progress in skill and craftsmanship since it began in the 1980s. Initially, diamond manufacturing factories were set up throughout the country, but the 70 major factories in operation today, which employ more than 15,000 workers, are located in Guangdong and Shandong Provinces, and in Shanghai. These factories are joint ventures between Chinese and foreign investors, or are entirely foreign or state owned; they produce polished diamonds valued at US\$700 million annually.

As the largest consumer market for diamond jewelry in China, and a major diamond-cutting center, Shanghai holds a pivotal position in the Chinese jewelry industry. Thus, in 2000 the first diamond exchange in China was organized in Shanghai. The year 2000 also saw the establishment of the China Diamond Cutters Association; one of their objectives is to help cutters win government support and incentives that will enable the Chinese diamond-cutting industry to compete internationally.

Details are also presented on the number of employees and the annual polished output in each of the major cutting centers, the automated production equipment introduced to reduce costs, and which countries have invested in the Chinese diamond manufacturing industry. MW

A highly unusual, 7.34 ct., Fancy Vivid purple diamond.

T. M. Moses, J. M. King, W. Wang, and J. E. Shigley, *Journal of Gemmology*, Vol. 28, No. 1, 2002, pp. 7–12.

The gemological properties of a 7.34 ct modified heart-shaped “Fancy Vivid” purple diamond are described. Diamonds with a saturated, pure purple color are extremely rare and few have been gemologically documented. Those purple diamonds that are recorded are generally small and pale in color, with a pink component.

When the diamond was examined face-up with magnification, the purple color appeared evenly distributed. However, when examined in other orientations, this diamond exhibited distinct purple color zones confined to parallel graining planes, similar to that often observed in brown, brown-pink, and pink to red diamonds. These colors are believed to arise from plastic deformation while the diamonds were still in the Earth’s mantle.

The diamond exhibited unevenly distributed, weak to moderate yellow fluorescence to long-wave UV radiation (and very weak yellow to short-wave UV). Its visible spectrum contained a broad absorption band centered at about 550 nm, as well as increasing absorption below 450 nm. Infrared spectroscopy showed it to be type IaA with a relatively high amount of nitrogen and very little hydrogen. Its GIA clarity grade was I1. JEC

Man vs. machine. C. Langford, *Canadian Diamonds*, Fall 2002, pp. 34–38.

The fledgling Canadian diamond-cutting industry, centered in Yellowknife, Northwest Territories (NWT), is

struggling with high business costs, limited skilled labor, and the need to increase production volumes. Even with the counteracting competitive advantages of guaranteed access to appropriate rough and the marketing advantage of “Canadian diamonds,” the Yellowknife-based cutting industry is calling on technology to make it truly viable. Advanced cutting technology is being used to reduce costs, improve quality, increase yield, and soften the demands on the skills of Canadian workers—many of whom are relatively new to the field.

Arslanian Cutting Works NWT, a subsidiary of Antwerp-based diamond trading and manufacturing company Rosy Blue, is typical of the three NWT cutting operations in its rapid move toward greater automation. It now has automated laser sawing, bruting, and blocking machines that are particularly applicable to the more labor-intensive components of the polishing process. As a result, Arslanian, along with the other NWT cutting operations, is poised for increased production at competitive costs. AAL

Multiple origins of alluvial diamonds from New South

Wales, Australia. R. M. Davies, S. Y. O’Reilly, and W. L. Griffin, *Economic Geology*, Vol. 97, No. 1, 2002, pp. 109–123.

The origin of alluvial diamond deposits in eastern Australia is an enigma, because no kimberlites or lamproites are known in the region and none of the usual diamond indicator minerals has been found in association with these diamonds. However, new studies have divided these diamonds into two distinct groups (A and B), which the authors suggest originate from separate sources and are formed by different geologic processes.

Group A diamonds are similar to those found in kimberlites and lamproites globally; they formed, conventionally, at two different times (3.4 and 2.1 billion years ago) in Archean and Proterozoic mantle sources. This classification is based on the similarities in their crystal form, internal growth features, mineral inclusions, and carbon isotopic ($\delta^{13}\text{C}$) composition to diamonds found in primary deposits worldwide. Nevertheless, the age and location of the primary host rocks for these diamonds remains elusive; multiple sources have been posed as possibilities, ranging from eroded Precambrian kimberlites and lamproites in eastern Australia to similar rock types in Antarctica.

Group B diamonds are unlike any others known worldwide in their combination of external and internal physical characteristics, mineral inclusions, and carbon isotopic composition. Such features are best explained by their having formed, unconventionally, more recently (ages between 320 and 220 million years ago are suggested) in a subduction zone environment. This coincides with the arc-continent collision that resulted in the development of the New England fold belt in eastern Australia. The diamonds were subsequently brought to the surface by magmas (type not specified) that formed during this same event. AAL

Recent developments in marine diamond mining. R. H. T. Garnett, *Marine Georesources and Geotechnology*, Vol. 20, No. 2, 2002, pp. 137–159.

Total output of diamonds from marine sources off the Namibian coast now exceeds 800,000 carats annually, surpassing onshore production in that country. More than 95% of the recovered marine diamonds are of gem quality, most weighing between 0.1 and 1.0 ct. While Namdeb Diamond Corp. (owned equally by the Namibian government and De Beers Centenary since 1994) is the major producer, junior public companies are also highly productive. Recovery of diamonds from the ocean, the most difficult form of placer mining, is much like a combination of mining and farming, as it is dependent on both weather and sea conditions.

Current equipment for marine mining has been successfully borrowed from other industries (e.g., placer gold mining). The grade (ct/m³ of gravel), seabed condition, water depth, and proximity to the coastline dictate the mining system that is employed. Major performance risks are effectively limited to: recovered grade, mining rate, system availability, and projected life of the reserves. Advantages of marine mining include: immunity to potentially disruptive onshore events; working sites that can be changed easily; simple tailings disposal as long as environmental requirements are observed; assignment of capital expenditures to transportable vessels and on-board assets that retain a reasonable liquidation value; and the fact that most costs are related directly to the mining operation and not to infrastructure maintenance. CT

GEM LOCALITIES

Ar-Ar ages in phlogopites from marble-hosted ruby deposits in northern Vietnam: Evidence for Cenozoic ruby formation. V. Garnier et al., *Chemical Geology*, Vol. 188, Nos. 1–2, 2002, pp. 33–49.

Radiometric age dating (⁴⁰Ar/³⁹Ar) was used to determine the ages of phlogopites and other micas in the marble-hosted ruby deposits at Yen Bai, Luc Yen, and Quy Chau in northern Vietnam. On the basis of these data and certain assumptions, the authors conclude that the rubies probably formed 40–35 million years ago. Further systematic dating of this nature may provide information about the timing of the continental collision and Cenozoic tectonics that caused the formation of these ruby deposits. CT

The Barra de Salinas pegmatites, Minas Gerais, Brazil. F. M. Bastos, *Mineralogical Record*, Vol. 33, No. 3, 2002, pp. 209–216.

The Barra de Salinas mines, in an area that is one of the world's largest and most famous producers of gem beryl and tourmaline, exploit several granitic pegmatites covering 1,500 ha (3,700 acres) in northeastern Minas Gerais.

Although reportedly first discovered around 1880, mining did not begin until 1942. Production was especially high between 1975 and 1984 when, for example, one mine (Vieirinho) produced 20 kg of superb rubellite, and another (Salto) produced six tons of pale aquamarine and cat's-eye tourmaline in just one year (1983). The pegmatites vary in size and mineralogical composition. Some contain mostly beryl, whereas others are predominantly tourmaline bearing. Minor gem species include blue topaz, garnet, and purple spodumene (kunzite). Mica, quartz, and feldspar are always associated with the gem minerals; most of the feldspar has decomposed to chalky white kaolinite.

The beryl is usually pink (morganite); pale blue aquamarine is less common. The tourmaline ranges from black to pink-red, blue, green, brown, and colorless. The Vieirinho pegmatite produced 50 kg of multicolored "watermelon" tourmaline from a single pocket. Many species of tourmaline (e.g., elbaite, liddicoatite, schorl, uvite, and dravite) have reportedly been identified. In some cases, both the beryl and the tourmaline can be color enhanced by heat treatment (e.g., brown tourmaline can become a beautiful "rose" red at 250°–400°C). The mines currently employ about 30 workers, and there is still great potential for future production. MT

Discovery of jadeite-jade in Guatemala confirmed by non-destructive Raman microscopy. F. Gendron, D. C. Smith, and A. Gendron-Badou, *Journal of Archaeological Science*, Vol. 29, No. 8, 2002, pp. 837–851.

In 1996, a small (3.5 × 2.5 × 1.5 cm) bluish green pebble was discovered in Rio El Tambor, a tributary of the Motagua River in Guatemala. The Motagua River valley is believed to be the main source of jadeite for pre-Columbian and more recent Mesoamerican jade artifacts. This pebble is composed predominantly (97%) of jadeite with minor amounts of rutile and titanite; quartz occurs as minute inclusions in the jadeite.

The authors suggest that this specimen has great archaeological and geological significance because: (1) it is the first specimen of jadeite to be found on the south side of the Motagua River (at least in recorded times), and (2) its mineralogical composition differs from any previously discovered specimen in Guatemala. Thus, the *in situ* source of this specimen, presumed to be on the south side of the Motagua River, has the potential to be the source of jadeite used in some Mesoamerican artifacts for which precise raw material counterparts have not been found. [Editor's note: The devastating floods of 1998 in Guatemala resulted in the discovery of new jadeite occurrences on both sides of the Motagua River; see the Gem News International entry on pp. 352–353 of this issue.] CT

Gem mining and sustainable environmental management in Sri Lanka. P. G. R. Dharmaratne, *Journal of Gemmology*, Vol. 28, No. 3, 2002, pp. 153–161.

Three methods of mining secondary gem deposits in Sri

Lanka are described. The open-pit method is used for mining deposits on or near the surface, and the shaft and tunnel method is used for mining deeper deposits. River dredging is used to mine placer deposits at the bottom of shallow rivers. Each method produces its own type of environmental degradation (e.g., damage to the vegetation cover or river banks).

Since 1972, the government has exercised control, including licensing, of the mining industry. To minimize environmental damage, regulations place restrictions on the type of mining that can be done in certain areas and call for the mandatory restoration of mined-out lands. Most damage (e.g., unfilled pits, soil heaps, and pollution of the waterways) occurs as the result of illicit mining. Specific legislation has been enacted to minimize the amount of such mining, but the nature of such operations, and the number of people involved, prevent its complete eradication. Lands damaged by illicit mining are, to some extent, being restored. WMM

Montana sapphires and speculation on their origin. R. B. Berg and J. P. Dahy, in P. W. Scott and C. M. Bristow, Eds., *Industrial Minerals and Extractive Industry Geology*, Geological Society of London, 2002, pp. 199–204.

Montana contains vast quantities of alluvial sapphires, but discovery of their primary host rocks has been surprisingly limited. Consequently, the origin of these sapphires is poorly understood. By studying xenoliths that occur within sapphire-bearing intrusive igneous rocks at Yogo Gulch and at a lesser-known locality at French Bar, near Helena, the authors present a hypothesis for the origin of all alluvial sapphire deposits in the state (including those at Rock Creek [Gem Mountain] and Dry Cottonwood Creek).

Xenoliths, some corundum-bearing, with lithologies similar to Precambrian basement rocks found in southwest Montana, have been identified in both the Yogo Gulch and French Bar (Cretaceous- or Tertiary-age) intrusives. Since corundum is found in the Precambrian basement in much of southwest Montana, the authors propose that similar rocks must exist underneath Yogo Gulch and French Bar. The magmatic intrusions at each locality must have incorporated large amounts of the corundum-bearing basement rocks during their initial rise toward the surface. The magma then naturally “heat treated” the corundum into gem-quality sapphire as the corundum-bearing xenoliths underwent partial assimilation. The sapphire-bearing intrusive rocks have since been completely eroded away (with the exception of Yogo Gulch and French Bar), creating the large alluvial deposits known today. KAM

Natural and heat-treated corundum from Chimwadzulu Hill, Malawi: Genetic significance of zircon clusters and diaspore-bearing inclusions. A. H. Rankin,

Journal of Gemmology, Vol. 28, No. 2, 2002, pp. 65–75.

Laser Raman microspectrometry was used to identify the inclusions in gem-quality rubies and other natural-color and heat-treated corundums from the eluvial soils of Chimwadzulu Hill, southern Malawi. Predominant were clusters of zircon crystals and planar groupings of multi-phase diaspore-CO₂ inclusions; tiny rutile needles and a single large amphibole inclusion also were identified. Although the inclusion assemblage may help distinguish Chimwadzulu corundums from those of other areas, these inclusions are not unique to this locality. The overall inclusion characteristics suggest the corundum formed in a metamorphic/hydrothermal environment, rather than in a magmatic host.

During heat treatment, the diaspore-CO₂ inclusions were destroyed. Diaspore converted to corundum and water; the latter and CO₂ were driven out through microfractures. The heat-induced microfractures also developed as “feathers” around the zircons. CT

A note on chocolate-brown opal associated with volcanic rocks in Somaliland. J. A. Kinnaird, *Journal of Gemmology*, Vol. 28, No. 2, 2002, pp. 81–84.

Precious opal from Somaliland comes from the Qabri Bahar area, near Jodha, close to the border with Ethiopia and Djibouti. Although similar to Ethiopian opals (from Shewa Province, 300 km to the west) in size, color, nodular appearance, trace-element chemistry, and origin (felsic volcanic rock of Miocene age), the Somaliland brown opals are the only ones reported to have intense play-of-color. Common opal has been found in a broad range of other colors, ranging from white to yellow, orange, and red. Diaphaneity ranges from transparent to translucent.

These opals have been on the market since the late 1990s. At present, the nodules are collected from the surface; no mining pits have yet been developed. Less than half of the nodules contain gem-quality opal, and only about 5% show a good play-of-color. WMM

Petrology of jadeite-bearing serpentized peridotite and its country rocks from northwestern Myanmar (Burma). G. H. Shi, W. Y. Cui, J. Liu, and H. X. Yu, *Acta Petrologica Sinica*, Vol. 17, No. 3, 2001, pp. 483–490 [in Chinese with English abstract].

The jadeite region, or Jade Tract, of Myanmar is characterized by bodies of serpentized peridotite that are predominantly derived from chromite-bearing dunite (a rock composed almost entirely of olivine). Metamorphic rocks peripheral to the dunite include blueschist, amphibolite, marble, and quartzite. The blueschist formed at a high pressure (greater than 0.8–1.0 GPa), and the amphibolite formed at a relatively low temperature (about 520°C). These and other data (e.g., the existence of three-phase inclusions in the jadeite) suggest that the jadeite region of Myanmar formed within a high- or ultrahigh-pressure,

low-temperature metamorphic belt.

The occurrence of high-quality jadeite is thought to relate to: the presence of ultramafic (peridotitic) host rocks of which chromite-bearing dunite is the most favorable; various schists, or other high-pressure, low-temperature metamorphic rocks peripheral to the ultramafic host rock; and proximity to a subduction or collision zone (to supply the fluids necessary for the formation of the jadeite). TL

JEWELRY HISTORY

Combined external-beam PIXE and μ -Raman characterization of garnets used in Merovingian jewellery. T. Calligaro, S. Colinart, J.-P. Poirot, and C. Sudres, *Nuclear Instruments and Methods in Physics Research B*, Vol. 189, Nos. 1–4, 2002, pp. 320–327.

A unique collection of 12 jewels that cover most of the Merovingian period (5th to 7th centuries) was discovered in the 1950s during excavations of a necropolis in the basement of the Saint-Denis Basilica, near Paris. These “cloisonné” style artifacts, which were widespread in Europe during the Dark Ages, contain 369 thin and polished slices of red garnet set in geometric gold or bronze settings. The authors characterized these garnets nondestructively by means of their major-element and trace-element contents (by PIXE analysis) and inclusions (by Raman microspectrometry). Archaeological objectives were to determine the provenance of the garnets and gem trade routes of the Dark Ages.

Ten of the jewels contained almandines, which originated from two sources based on their distinctive abundances of Ca, Mg, and Y. One jewel contained pyropes, also from two sources (based on the presence and absence of Cr), while the garnets in one jewel were composed of intermediate almandine-pyrope (i.e., rhodolite) with chemical characteristics indicative of just one source. Eight different mineral inclusions (rutile, ilmenite, quartz, calcite, apatite, zircon, monazite, and graphite) were identified in almandines from one of the two sources, in contrast to only three (rutile, apatite, and monazite) from the other source; no mineral inclusions were reported in the pyrope and rhodolite garnets. The authors suggest that the almandines came from two different localities in India, whereas the pyrope (both sources) originated from Bohemia (Czech Republic), and the rhodolite came from Sri Lanka. CT

The Wernher Collection. M. C. McLaughlin, *Jewelers' Circular Keystone*, Vol. 173, No. 12, 2002, pp. 86–89.

The largest collection of medieval and renaissance jewelry in the United Kingdom, amassed by one of the founders of De Beers, has gone on permanent display in London. Sir Julius Wernher, born in Germany in 1850, went to work in Kimberley, South Africa, in the early

1870s as the representative for the diamond merchant firm of Jules Porgès. Wernher took control of Porgès's firm in 1884, eventually allying with Cecil Rhodes in his quest to take control of the Kimberley diamond mines. In 1888, Rhodes formed De Beers Consolidated Mines, naming Wernher as a lifetime governor.

Wernher assembled his jewelry collection between 1890 and 1905, along with a number of Old Master paintings and *objets d'art*. The collection remained in the family estate until the summer of 2002, when it went on public display at Ranger House, an 18th century mansion in Greenwich Park, London. Most of the jewelry is from the Spanish Renaissance and consists of pendants set with opals, pearls, rubies, sapphires, and diamonds. The exhibition was arranged by English Heritage, an advisory commission on preserving historical pieces, which has the collection on a 125-year loan. RS

JEWELRY MANUFACTURING

The art of concave faceting. S. Prosper, *Canadian Gemologist*, Vol. 23, No. 2, 2002, pp. 56–59.

The concave faceting or OMF (optically magnified facet) machine has been in use for more than a decade. Invented by Douglas L. Hoffman and patented in 1990, the OMF machine is currently manufactured by his son, Zane D. Hoffman.

Concave facets on the pavilion of a stone act as internal convex mirrors, reflecting light rays from more directions than a flat faceted stone, thus increasing brilliance and scintillation. The rough material should be transparent and relatively inclusion free. Color bands, pleochroism, and high birefringence are factors to be considered, and light-colored gems typically yield better results than darker ones. Decreased yield (by 20%–25% weight) and increased production costs result in generally higher per-carat prices than for comparable conventionally faceted stones. CT

Sound advice: Using ultrasonic technology to carve gemstones in quantity. S. C. Shank, *American Jewelry Manufacturer*, Vol. 47, No. 1, 2002, pp. 29–34.

Duplication, by freehand, of an existing gemstone carving almost invariably leads to variances among the stones. However, ultrasonic cutting technology allows mass production of customized carved gemstones. This process uses sound waves to vibrate a hard cutting tool in conjunction with an abrasive slurry. The ultrasonic machine converts electrical energy into mechanical energy, amplifying it by the use of sound (it is not to be confused with ultrasonic cleaning equipment).

The first step in ultrasonic cutting technology is fashioning an original model. This model can be made from almost any material (e.g., wax, metal, or stone), but it should be at least 0.5 mm thick so that it is less

susceptible to cracking during manufacture. The second step involves making the cutting tool, which is an exact reverse image of the desired stone. This is accomplished by taking a wax impression of the model and then making a metal casting of the impression (stellite steel, a Ni-Cr-Co alloy, is recommended). Before the actual fashioning (the third step) of the gem, the rough must be sawn and ground into slabs. Although this step can be time consuming, it is effective in reducing cutting time and increasing tool life, and it results in a better carving. The fashioned pieces are then sanded, and both high-polish and matte finishes can be employed. JS

SYNTHETICS AND SIMULANTS

Channel constituents in synthetic beryl: Ammonium. R. I. Mashkovtsev and V. P. Solntsev, *Physics and Chemistry of Minerals*, Vol. 29, No. 1, 2002, pp. 65–71.

The infrared and electron paramagnetic resonance (EPR) spectra of c-axis channel constituents in beryls synthesized hydrothermally in the presence of NH_4Cl were investigated to determine the forms of the ammonium ion incorporated into this structural site. Three commercially available hydrothermal synthetic beryls (Biron, Regency, and Taurus), as well as several synthetic beryls grown experimentally in Russia, were used in the study. The results were compared to natural beryl from the Ural Mountains of Russia.

IR spectra show bands assigned to the NH_3 molecule and NH_4^+ ion. EPR spectra after gamma irradiation showed that the $\text{NH}_3^{\cdot+}$ (I) radical can be generated from both the NH_4^+ ion and from the NH_3 molecule. After heating at room temperature, the $\text{NH}_3^{\cdot+}$ (II) radical replaces the $\text{NH}_3^{\cdot+}$ (I) radical. AI

A comparison between a flux grown synthetic ruby and an untreated natural ruby. J. M. Duroc-Danner, *Journal of Gemmology*, Vol. 28, No. 3, 2002, pp. 137–142.

Synthetic rubies grown by the flux method (which are far less common than the widely produced Verneuil flame-fusion or Czochralski crystal-pulled synthetics) may contain inclusions that appear similar to those found in some untreated natural rubies. In this particular case, however, the separation was fairly easy because the most obvious signs of flux synthesis (e.g., unmelted flux residue and trigonal and hexagonal platinum platelets) were present in the flux-grown ruby. Had these inclusions been excluded during the cutting process, the separation would have been more difficult, especially since flux synthetic rubies may contain parallel color zones with straight and angular growth features, as observed in most natural corundum. All of the inclusions in each stone examined are described, as well as the part each played in the identification process. WMM

TREATMENTS

De Beers' research yields HPHT's secrets. C. Welbourn and D. Fisher, *Rapaport Diamond Report*, Vol. 25, No. 17, 2002, pp. 44–45.

The introduction of color-improved high pressure/high temperature (HPHT)-treated diamonds in March 1999 prompted major gemological laboratories in Europe and the U.S. to initiate research for detection of the treatment. Techniques used include UV-Vis and IR absorption spectroscopy, as well as laser-excited photoluminescence (PL) spectroscopy. Carried out at cryogenic temperature, the PL technique is especially valuable for investigating type II diamonds—which are prime candidates for decolorization by HPHT treatment. De Beers, through the Gem Defensive Programme supported by the Diamond Trading Company (DTC) Research Centre, is assisting laboratories by developing prototypes of practical instruments to deal with the challenges (both current and anticipated) of identifying this treatment. Although the identification equipment currently in use can distinguish the vast majority of HPHT-treated diamonds, there are always a small number of stones for which the identification is uncertain.

De Beers offers the following practical advice to the trade. Colorless and near-colorless diamonds should be checked to see if they are transparent to UV radiation and, therefore, likely to be type II diamonds amenable to HPHT treatment; such diamonds should be referred to a suitably equipped gemological laboratory. Those that are opaque to UV radiation will be type I and unlikely to have been HPHT treated. All fancy yellow, greenish yellow, pink, and blue diamonds should be sent to a qualified laboratory for evaluation. The DTC suggests that, ultimately, the only option for UV-transparent type II diamonds (which are actually uncommon) is requiring a written declaration from the supplier that the diamonds are natural and untreated. The same applies to the fancy-color diamonds mentioned above. MT

MISCELLANEOUS

Birth of a birthstone. R. Weldon, *Professional Jeweler*, Vol. 5, No. 12, 2002, p. 33.

Tanzanite has been named the third birthstone for December (with turquoise and zircon). Key industry organizations, including the American Gem Trade Association (AGTA), International Colored Stone Association (ICA), and the Jewelers of America (JA) signed on to the proposal, making tanzanite the first gem to be added to the birthstone list since 1912. The JA added the information to its gemstone information leaflets, and the AGTA placed full-page announcements in *Town & Country* and *In Style* magazines. AGTA executive director Douglas K. Hucker said that tanzanite is the second most popular colored gemstone in the U.S., behind sapphire. RS

DYEING

This is likely the oldest form of gem treatment. It involves the introduction of a colored substance into surface-reaching fractures or into gems with a porous structure...

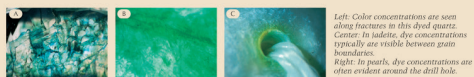

CHEMICAL BLEACHING

Chemicals are used to lighten or whiten the color, as well as to remove unwanted or modify coloration.

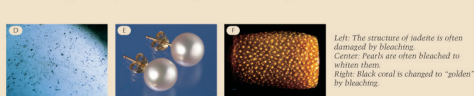

AMBER

Thermal enhancement - to induce "spangles" (D) - to improve transparency (D, NAD) - to produce a dark shallow surface coloration (D) (2)

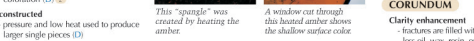

AMMOUILITE

Surface coating - a coating of plastic is applied to "protect" and "seal" the thin indented layer (D)

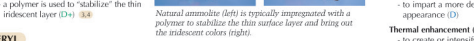

BERYL

Beryl clarity enhancement - fractures are filled with an essentially colorless oil, wax, resin, or epoxy to reduce their visibility (D) (8)(3)(3)



Thermal enhancement

to remove the green color component of aquamarine (ND) (9)

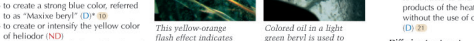

CHALCEDONY

Dyeing - a colored substance or chemical is introduced into the porous structure to produce a more desirable color appearance (D) (1)



CHRYSOBERYL

Clarity enhancement - fractures are filled with an essentially colorless substance to reduce their visibility (D) (3)



CORAL

Chemical bleaching - to create "golden" coral from black coral (ND) (9)(8)



SURFACE COATING

Different types of this treatment may have a variety of desired effects: (A) The application of a colored substance to a portion of the surface...

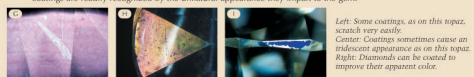

IMPREGNATION

Filling the voids in a porous gem material with a wax or polymer may improve its appearance and durability.

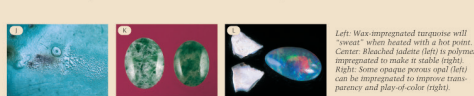

DIAMOND continued

High pressure/high temperature (HPHT) - to remove the brown color of some type Ia diamonds to produce a more desirable color appearance (D, NAD) (3)(3)(3)



PEARL

Dyeing - a colored substance is introduced into the porous structure to create a more desirable color appearance (D, NAD, ND) (8)



OPAL

Dyeing - a colored substance is introduced into the porous structure to create a more desirable color appearance (D, NAD, ND) (8)

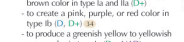

PEARL continued

to stabilize hollow pearls or cultured pearls (D) (8)(3)



QUARTZ

Dyeing - a colored substance is introduced into the porous structure to create a more desirable color appearance or simulate the color of another material (D) (8)

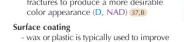

JADE

Dyeing - a colored substance is introduced between grain boundaries and along fractures to produce a more desirable color appearance (D, NAD) (3)(8)

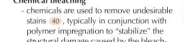

LAPIS LAZULI

Dyeing - a colored substance is introduced into the porous structure, and along fractures, to produce a more desirable color appearance (D) (8)



THERMAL ENHANCEMENT

Heat is often applied to modify color and/or clarity. Some gems are exposed only to "low temperature" heating (under 1000°C)...



DIFFUSION TREATMENT

Color (e.g., blue, orange, yellow, and red in corundum) or asterism is induced by diffusing elements into the lattice of the stone with high temperatures.

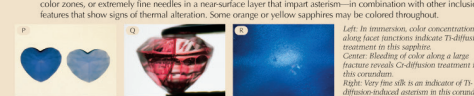

IRRADIATION

Some gems are exposed to various forms of radiation (e.g., electrons, gamma rays, or neutrons) to modify their color. The resultant coloration may be shallow or permeate throughout the gem, and it may be stable or unstable to heat and/or light.

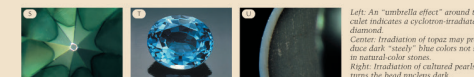

CLARITY ENHANCEMENT

A liquid, semi-solid, or solid substance (such as oil, wax, resin, polymer, or glass) is introduced into surface-reaching fractures to reduce their visibility and thus improve the apparent clarity of the gem.

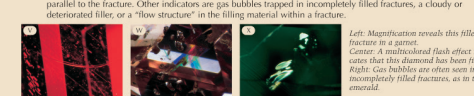

KEY TO SYMBOLS

D = Those treatments that are detectable using visual observations and/or standard gemological instrumentation. D+ = Those treatments that are detectable but require advanced analytical techniques which may not be readily available. NAD = Those treatments that are not currently detectable. ND = Those treatments that are not always detectable. * = Very unstable to light.

This chart was prepared in conjunction with G.I. Smith and S.S. McClure. © 2002 Gemological Institute of America. All rights reserved. The information provided herein is based on IGI, GIA, and G.I. Smith 2002. "Gemstone enhancement and detection in the 1990s." Gem & Gemology, Vol. 36, No. 4, pp. 4-39. Photographs by Tim Herzig, David Wright, Philip Herzig, John Kavanagh, David Anderson, Kenneth Korman, Mark Tomasco, Robert Wainwright, and Harold van der Vorst, 1991.